



List of Cut Wet Patterns for Asphalt Tyres

Only valid for European Rally Trophy tarmac events if authorised by the Supplementary Regulations

 COOPERTIRES	Page 2
 YOKOHAMA	Page 7
 DMACK	Page 9
 MRF	Page 13
 MICHELIN	Page 18
 PIRELLI	Page 26
 HOOSIER RACING TIRE	Page 29
 EXTREME PERFORMANCE TYRES	Page 33
 DUNLOP	Page 35
 Hankook	Page 36



COOPER DISCOVERER TARMAC DT02 - 225/40R18 - WET CUTTING PATTERN – PHASE 1

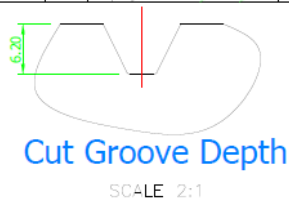
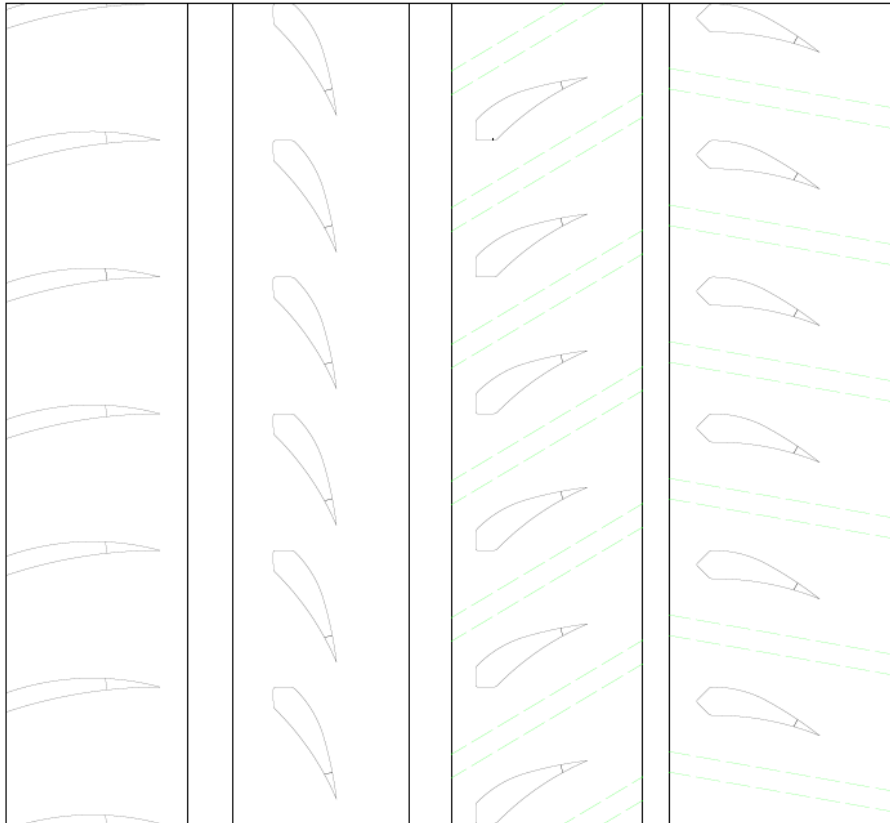

*Green Lines to Be Cut

**COOPER DISCOVERER TARMAC DT02 - 225/40R18 - WET
CUTTING PATTERN – PHASE 2**

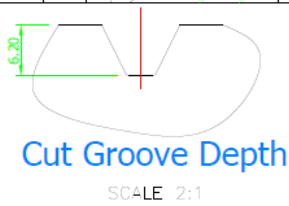
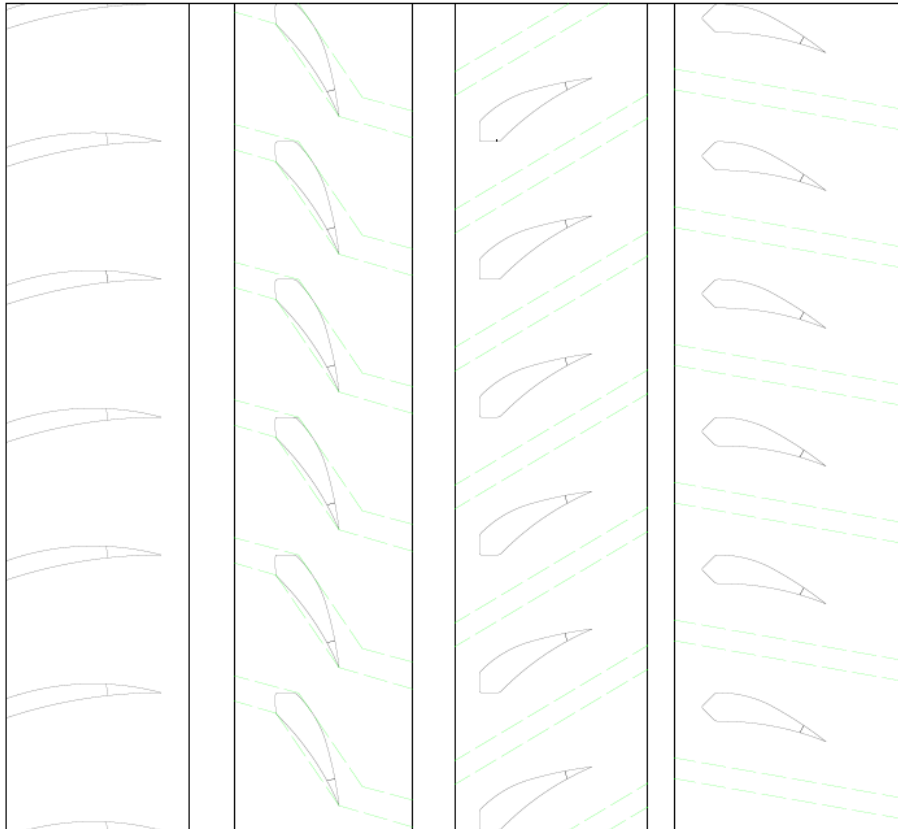

*Green Lines to Be Cut

COOPER DISCOVERER TARMAC DT1 - 205/45R17 - WET CUTTING PATTERN

DRAWING REFERENCE

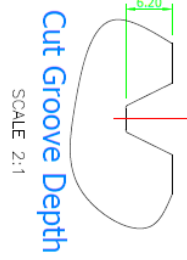

*Green Lines to Be Cut

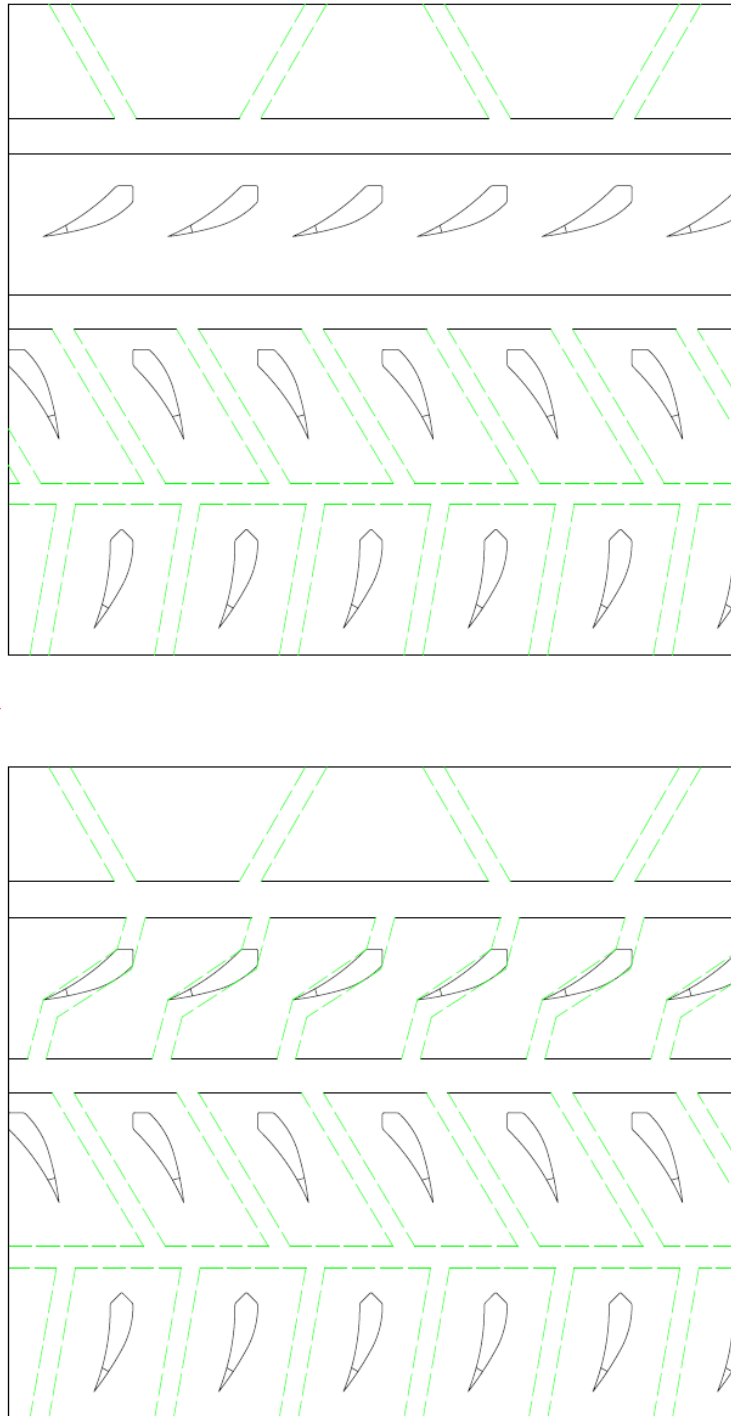

COOPER DISCOVERER TARMAC DT1 - 195/50R16 - WET CUTTING PATTERN

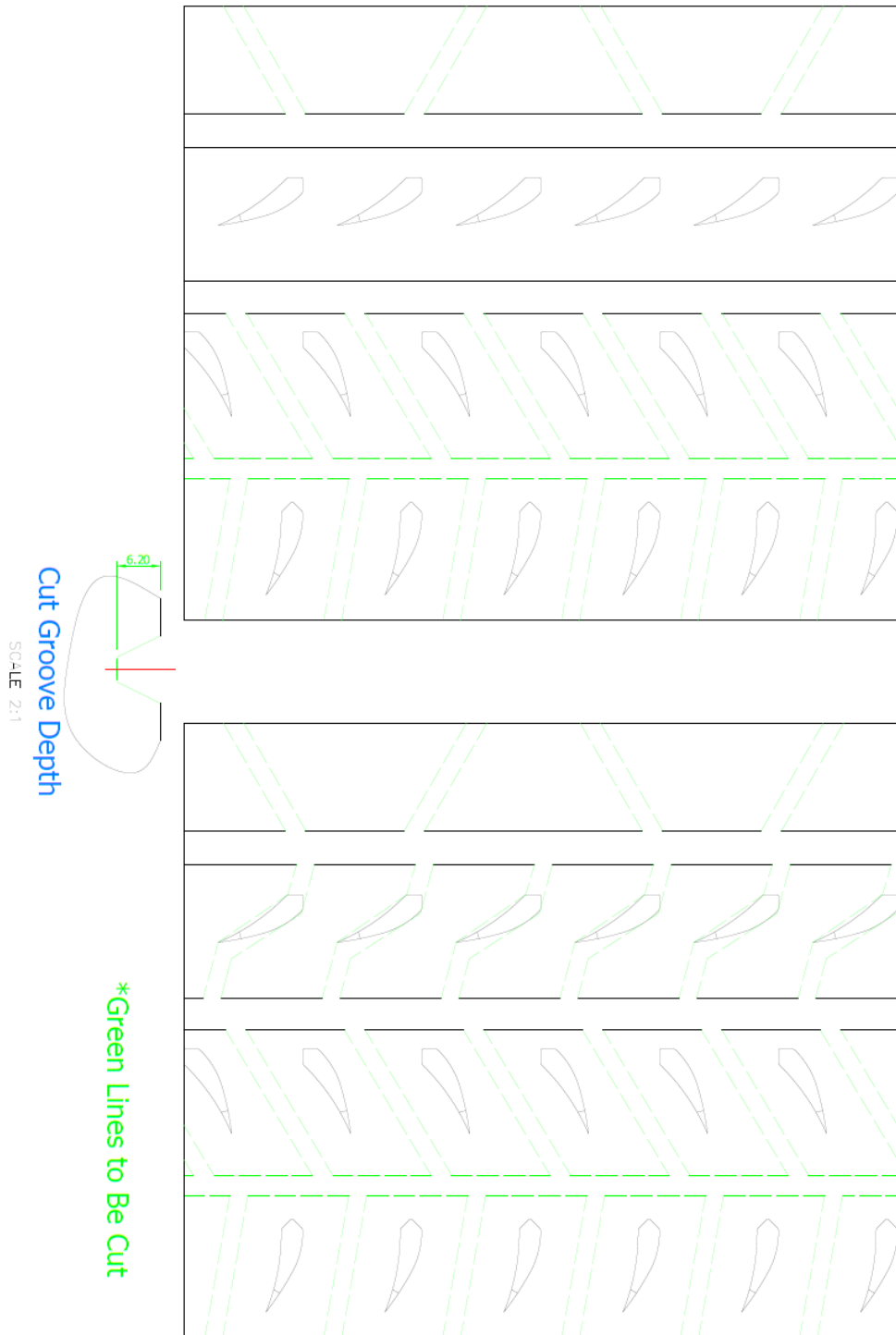

COOPER DISCOVERER TARMAC DT1 - 195/50R15 - WET CUTTING PATTERN

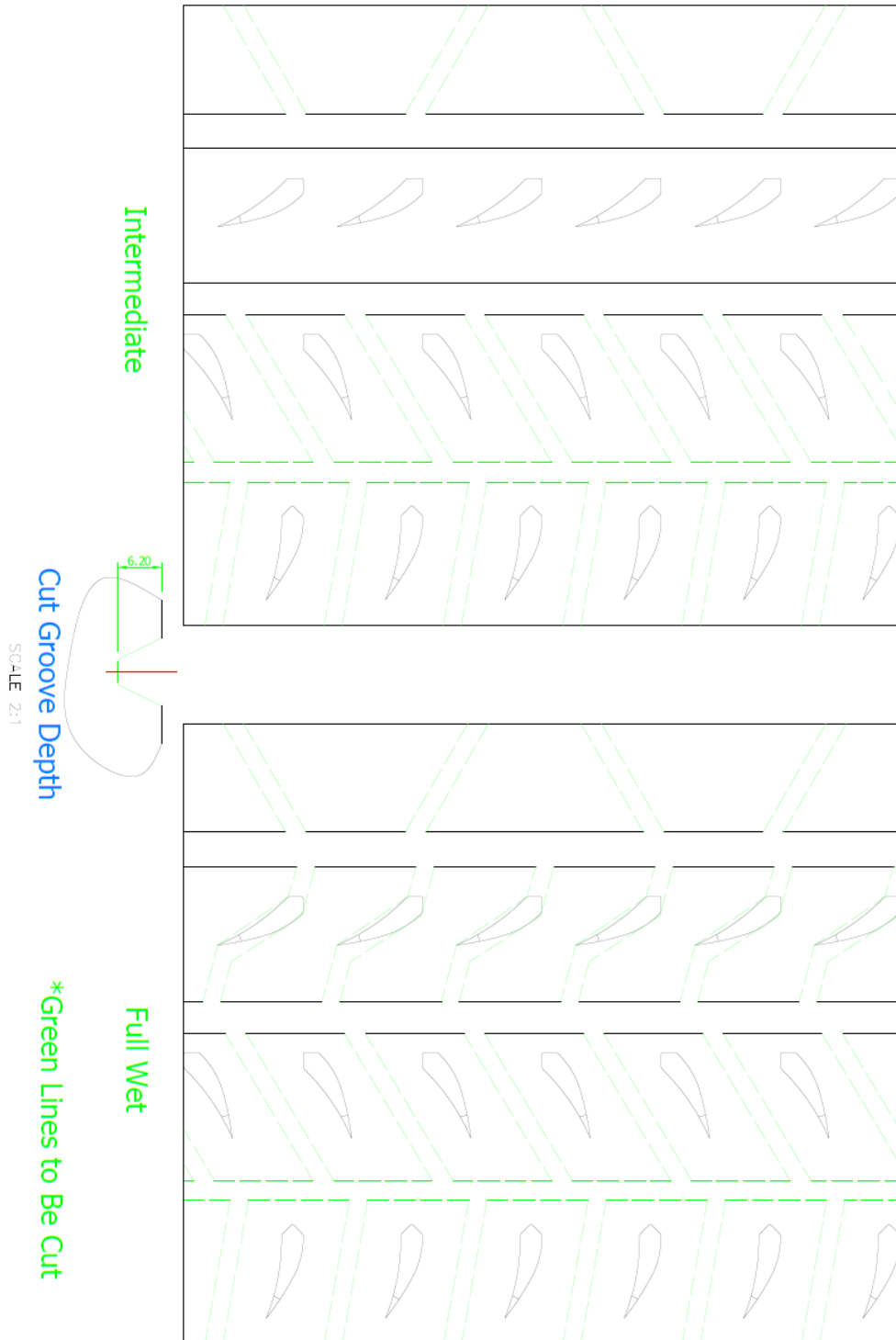

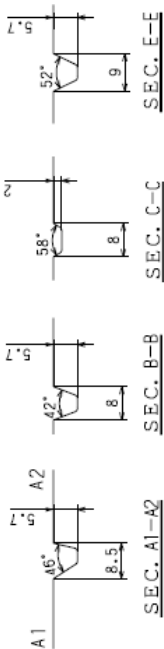

In the control area
 5.5mm grooves-18.1%
 Total grooves-22.2%
 ----- Control area 170X140
 Tyre weight 9.7kg

HAND-CUT GROOVE RECOMMENDATION

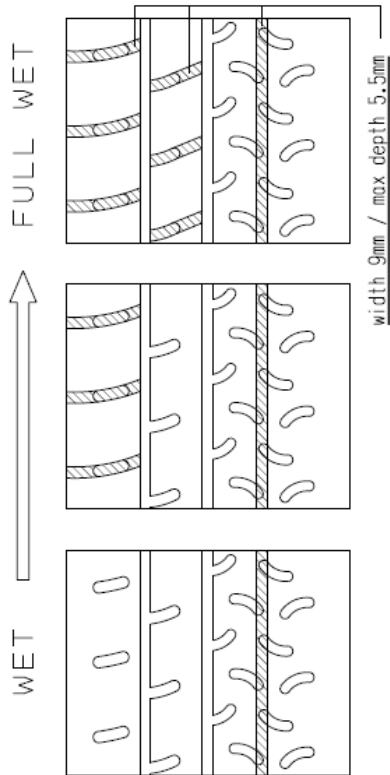

PATTERN NAME
A051A

PRODUCT NAME
YOKOHAMA ADVAN A051T

SIZE 210/650R18

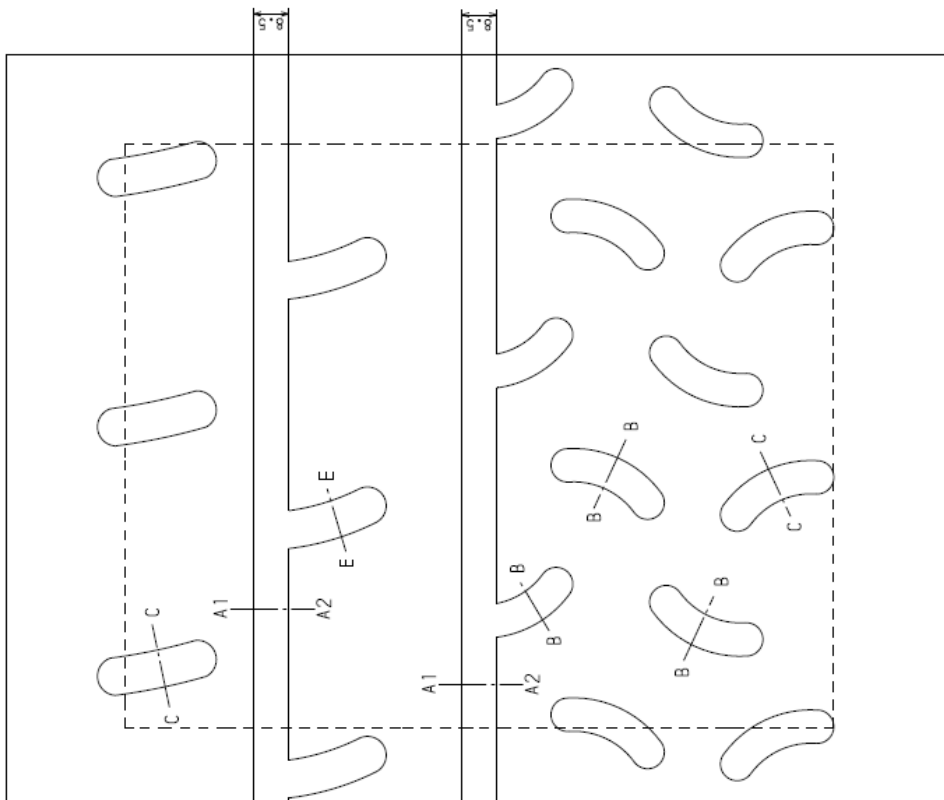

HAND-CUT GROOVE RECOMMENDATION

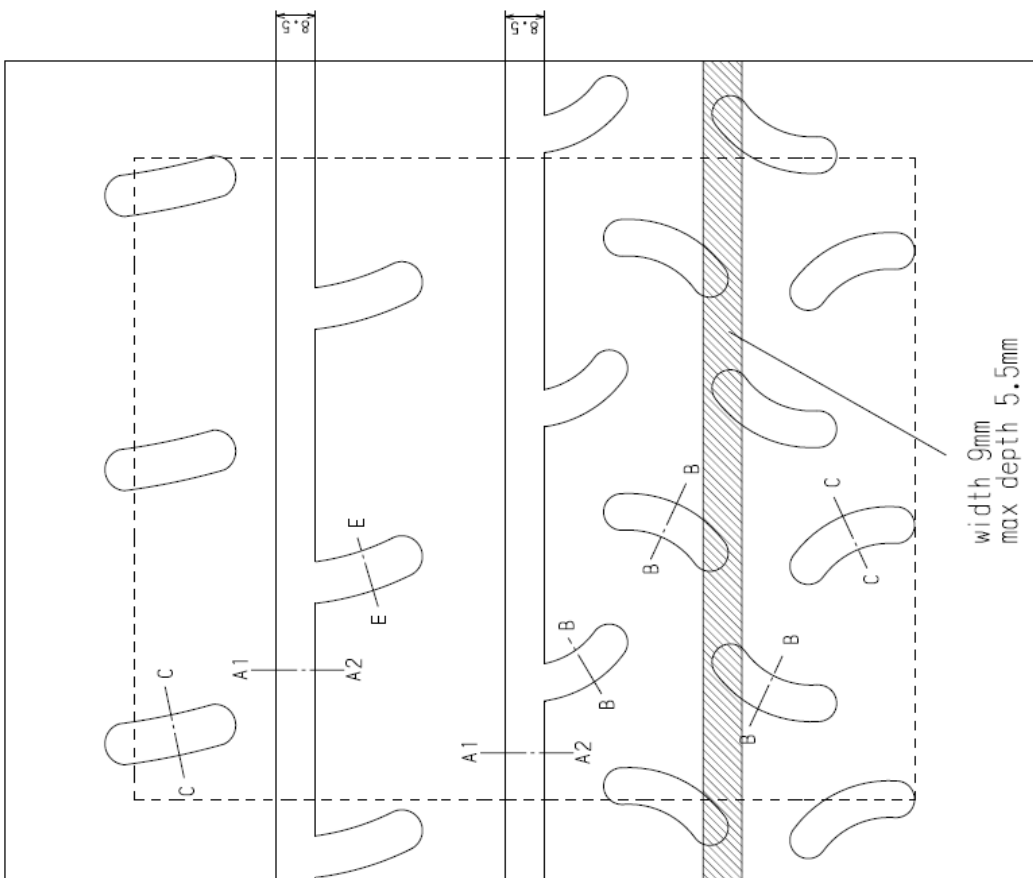
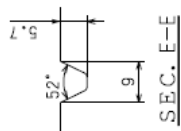
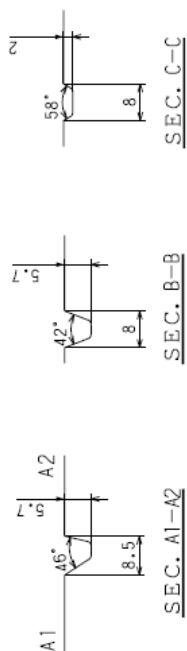

In the control area
 5.5mm grooves-18.1%
 Total grooves-22.2%

----- Control area 170X140

Tyre weight 9.7kg

PRODUCT NAME
YOKOHAMA ADVAN A051T

PATTERN NAME
A051A

SIZE 210/650R18

DMT RC2

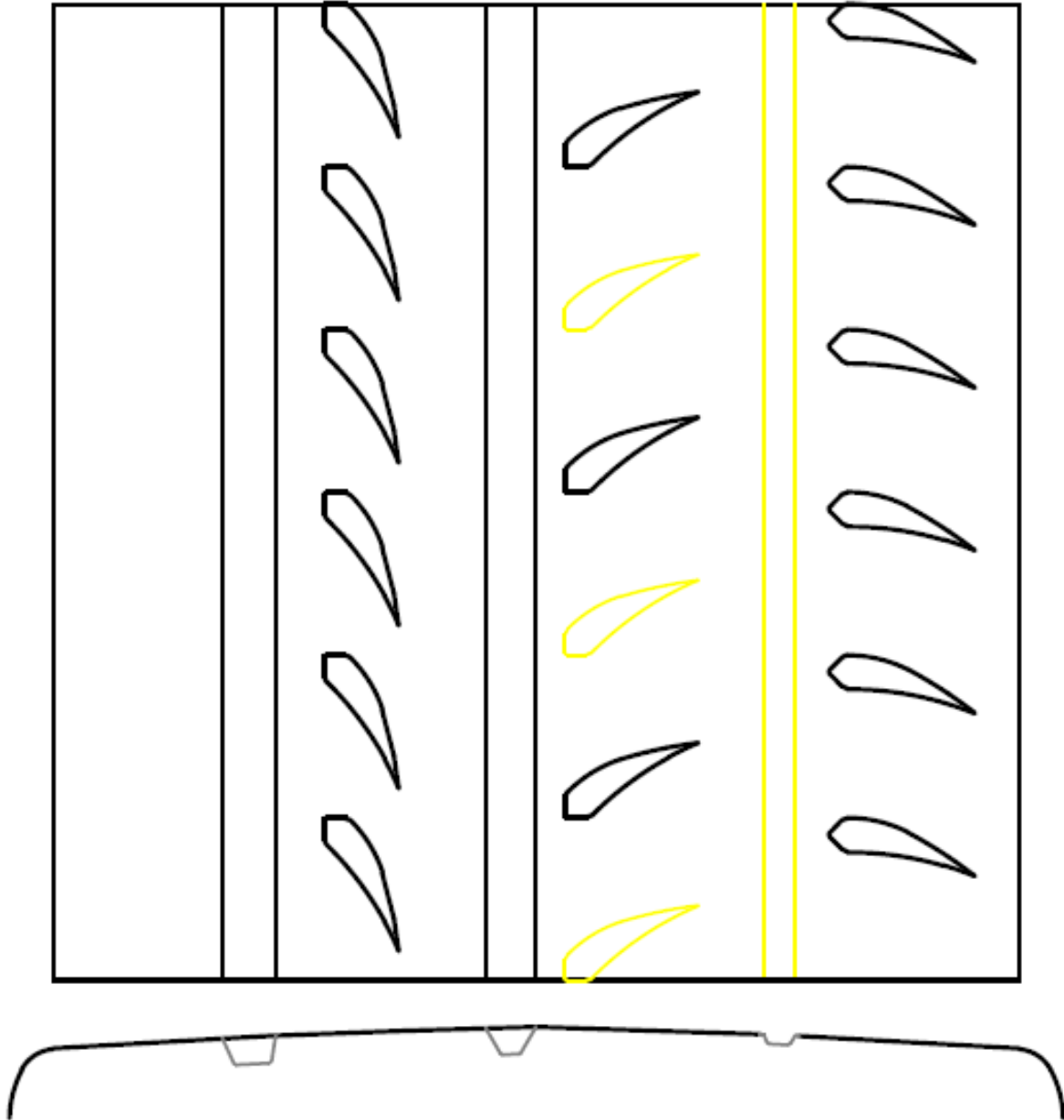

DMT RC2 Wet Cut

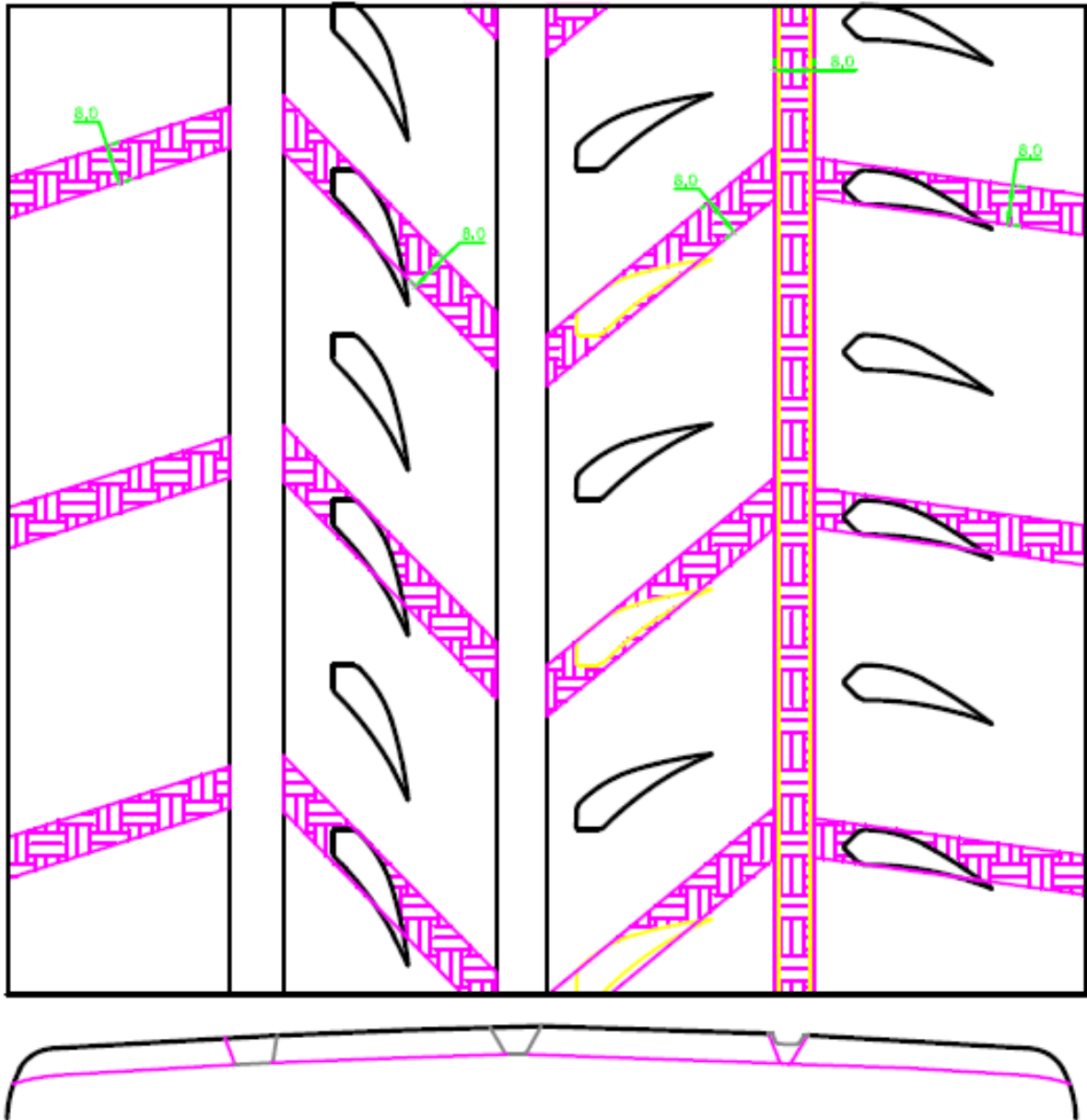

DMT RC22

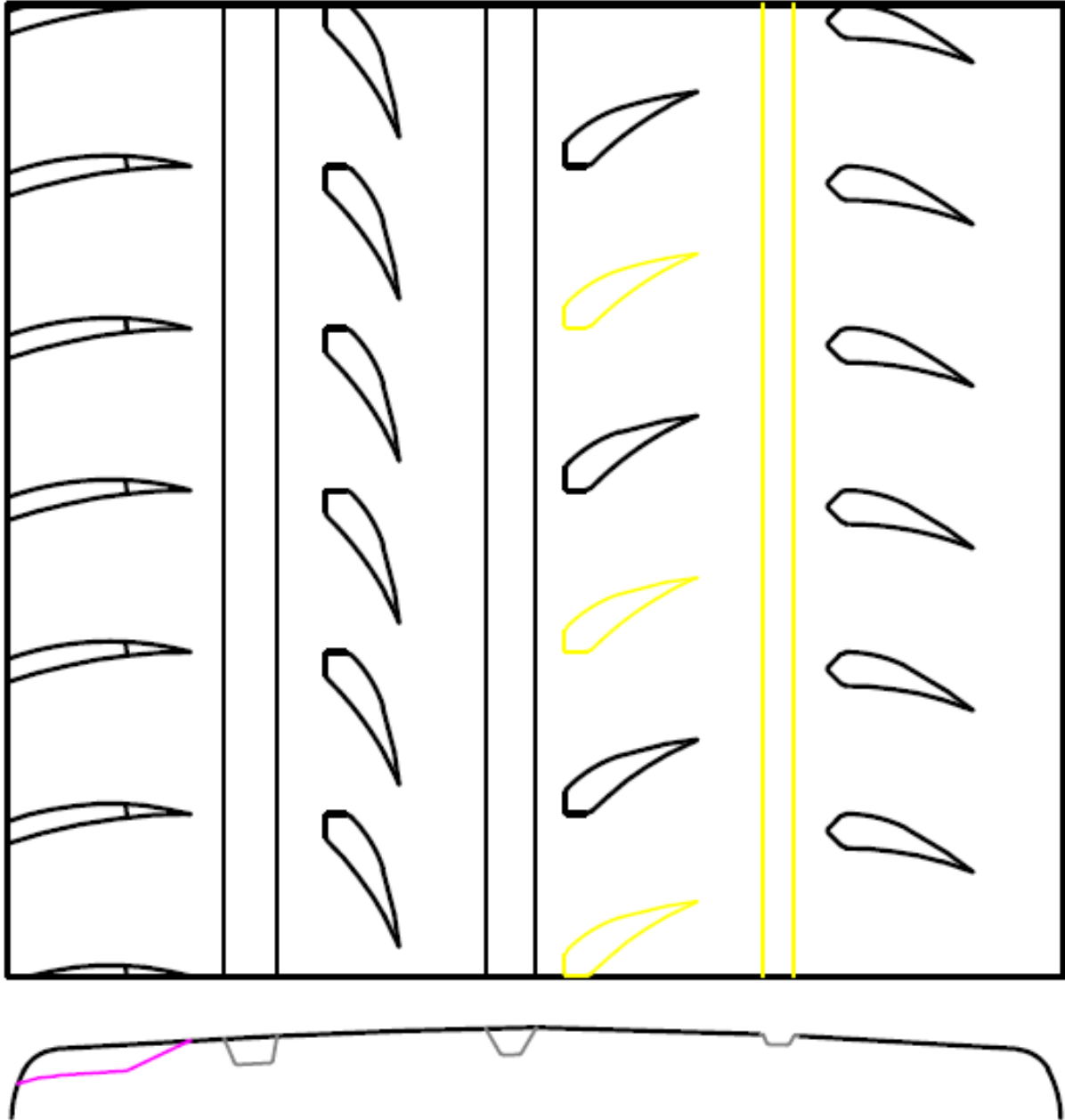

DMT RC22 Wet Cut

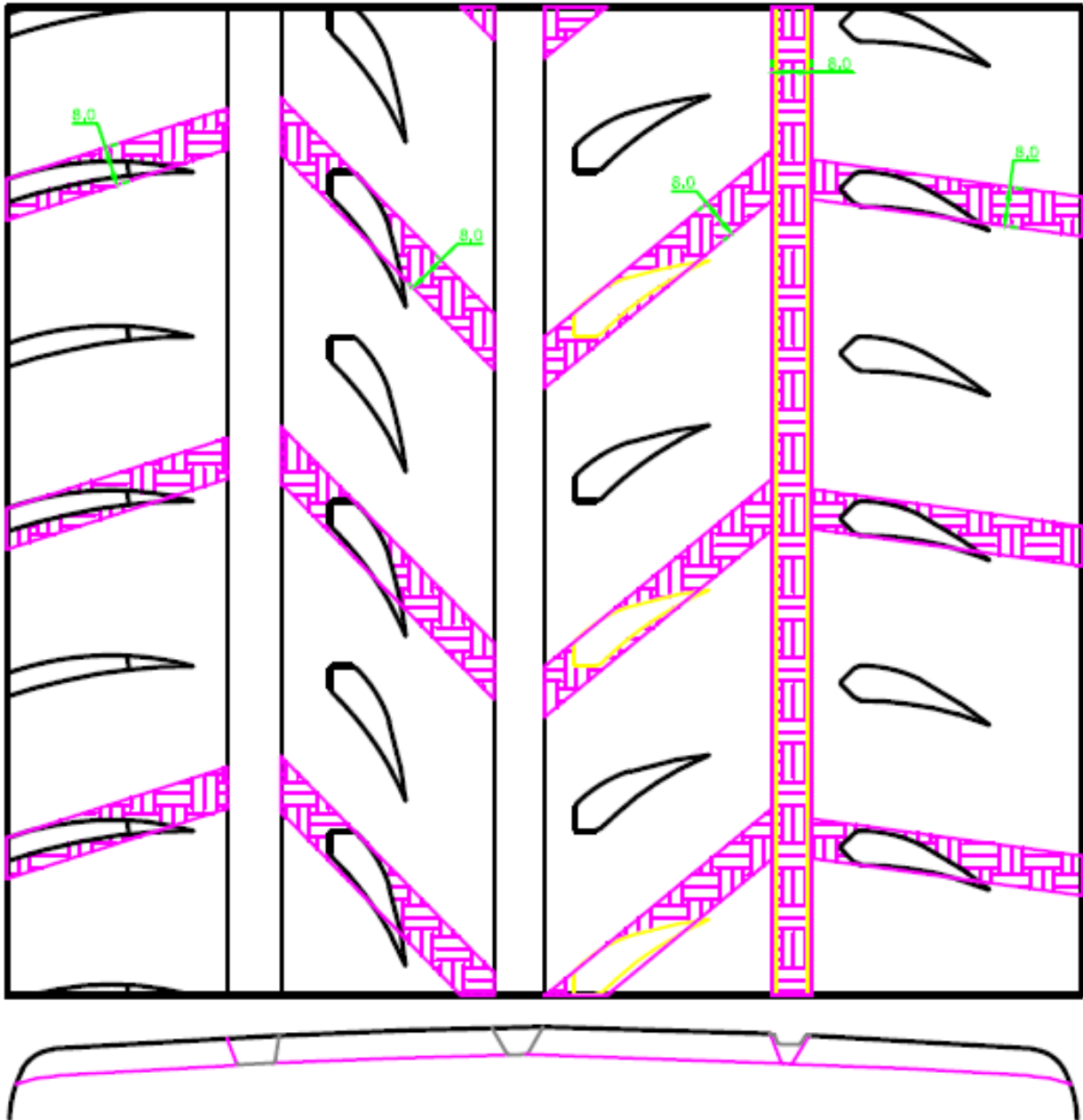

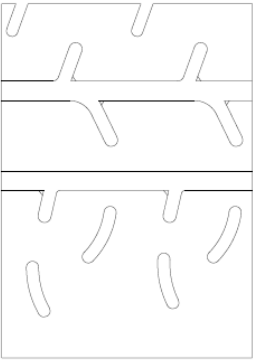
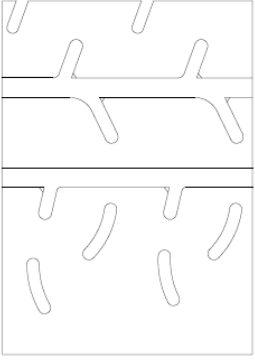
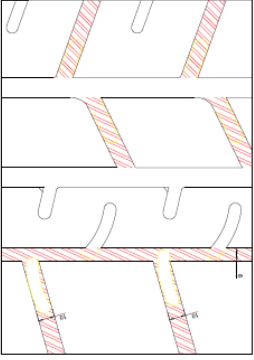

MRF

	 <p>235/40 R18 ZTA</p>	 <p>235/40 R18 ZTA HC-1 LIGHT RAIN</p>	
	 <p>235/40 R18 ZTA HC-2 HEAVY RAIN</p>		

NO.	REV.	DATE	BY	CHKD.	APP.	REASON FOR CHANGE	SCALE	SHEET NO.	TOTAL SHEETS

DRAWN	CHECKED	DESIGNED	APPROVED	DATE

235/40R18 ZTA TL - PATTERN HAND CUT-WET
 PROJECT: P03BR-HC-00
 SHEET: 00



MRF



195/50 R16 Tarmac Rally - Hand Cut Pattern for Wet

Dry Pattern
Groove Ratio > 17%

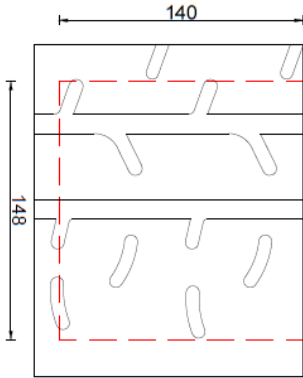

Light Rain
Groove Ratio > 27.5%

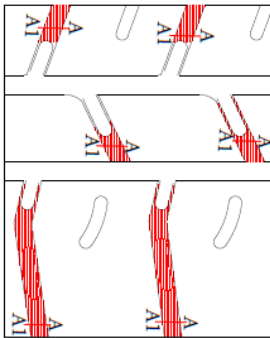

Heavy Rain
Groove Ratio > 32.5%

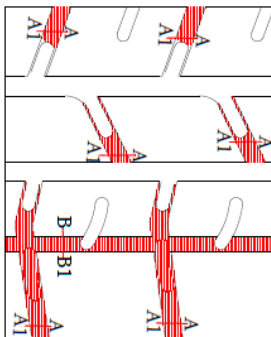

Control area 148 x 140 mm (Dotted Line)

SECTION: A-A1

SECTION: B-B1

A-A1 - 10 mm
B-B1 - 8 mm
Hand Cut Groove Portion

CLASS 8"
RIM 6.5"

ITEM	DESCRIPTION	UNIT	QTY	REMARKS
1	Hand Cut Groove Portion	m ²		
2
3
4
5
6
7
8
9
10
11
12
13
14
15
16
17
18
19
20
21
22
23
24
25
26
27
28
29
30
31
32
33
34
35
36
37
38
39
40
41
42
43
44
45
46
47
48
49
50
51
52
53
54
55
56
57
58
59
60
61
62
63
64
65
66
67
68
69
70
71
72
73
74
75
76
77
78
79
80
81
82
83
84
85
86
87
88
89
90
91
92
93
94
95
96
97
98
99
100



235/40 R18 Tarmac Rally - Hand Cut Pattern for Wet

Dry Pattern
Groove Ratio > 17%

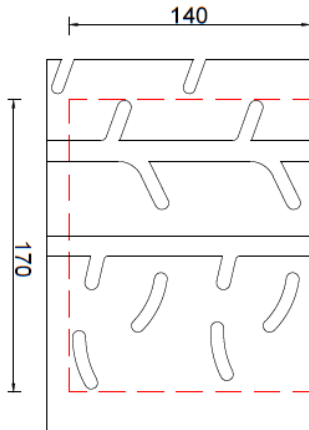

Light Rain
Groove Ratio > 27.5%

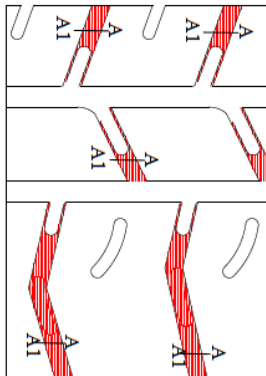

Heavy Rain
Groove Ratio > 32.5%

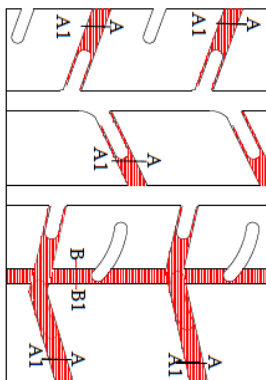

Control area 170 x 140 mm (Dotted Line)

SECTION: A-A1

SECTION: B-B1

A-A1 - 10 mm
B-B1 - 8 mm

Hand Cut Groove Portion

CLASS 9"
RIM 8.0"

GENERAL INFORMATION		MRF	
ITEM NO.	DESCRIPTION	UNIT	QUANTITY
235/40R18 ZTA TL - HAND-CUT WET PATTERN			
<p>235/40R18 ZTA TL - HAND-CUT WET PATTERN</p> <p>F-A-0018</p>			



Category : GT Asphalt Rally
Dimension : 24 / 65 – 18 TL PILOT SPORT R
Cutting plan of Pilot Sport R tread pattern for RGT

Clermont-Ferrand the 20/05/2020

cuts (red parts) with Blade R2



Extérieur véhicule

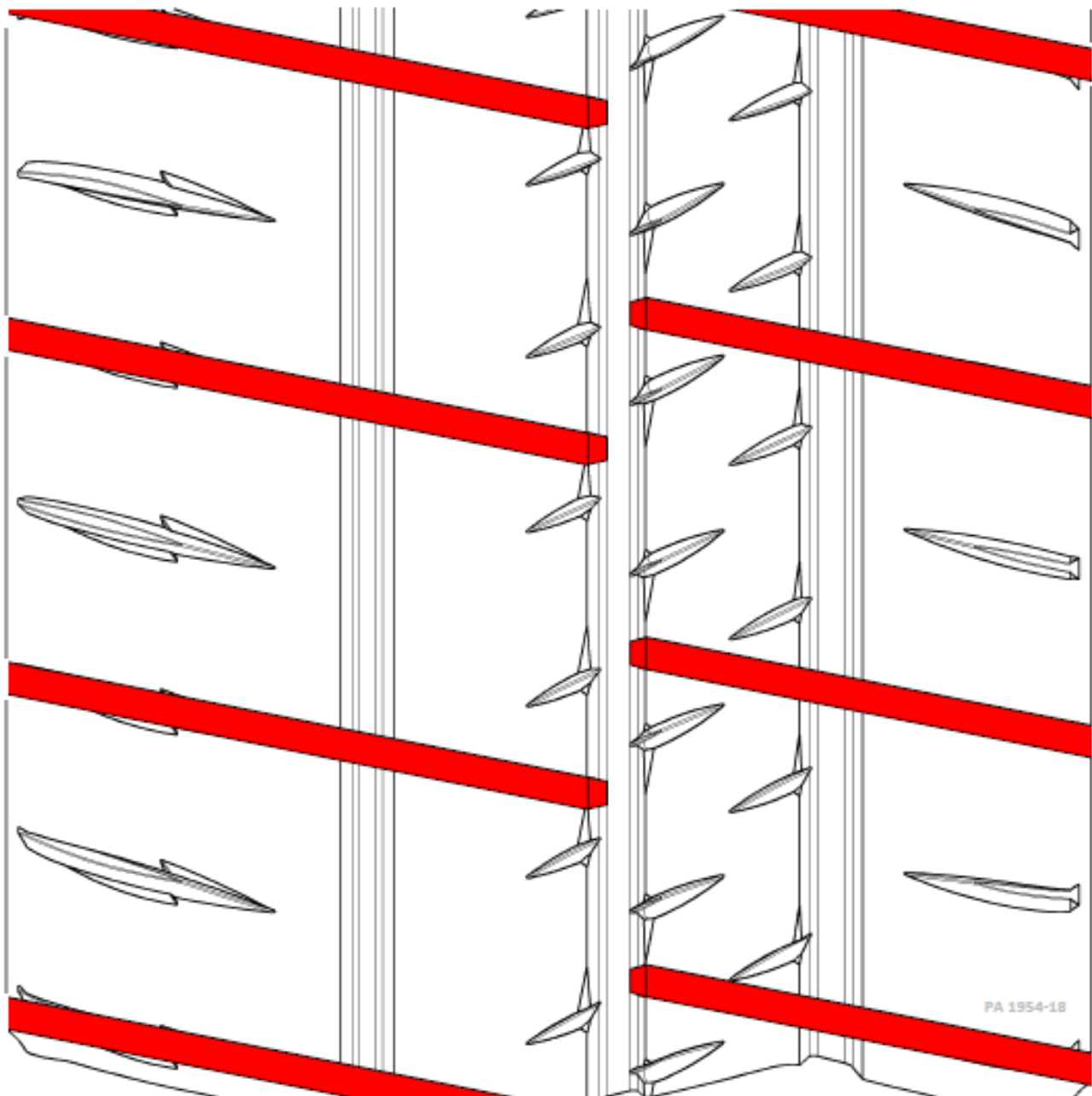

PA 1954-18



Category : GT Asphalt Rally
Dimension : 29 / 65 – 18 TL PILOT SPORT R
Cutting plan of Pilot Sport R tread pattern for RGT

Clermont-Ferrand the 20/05/2020

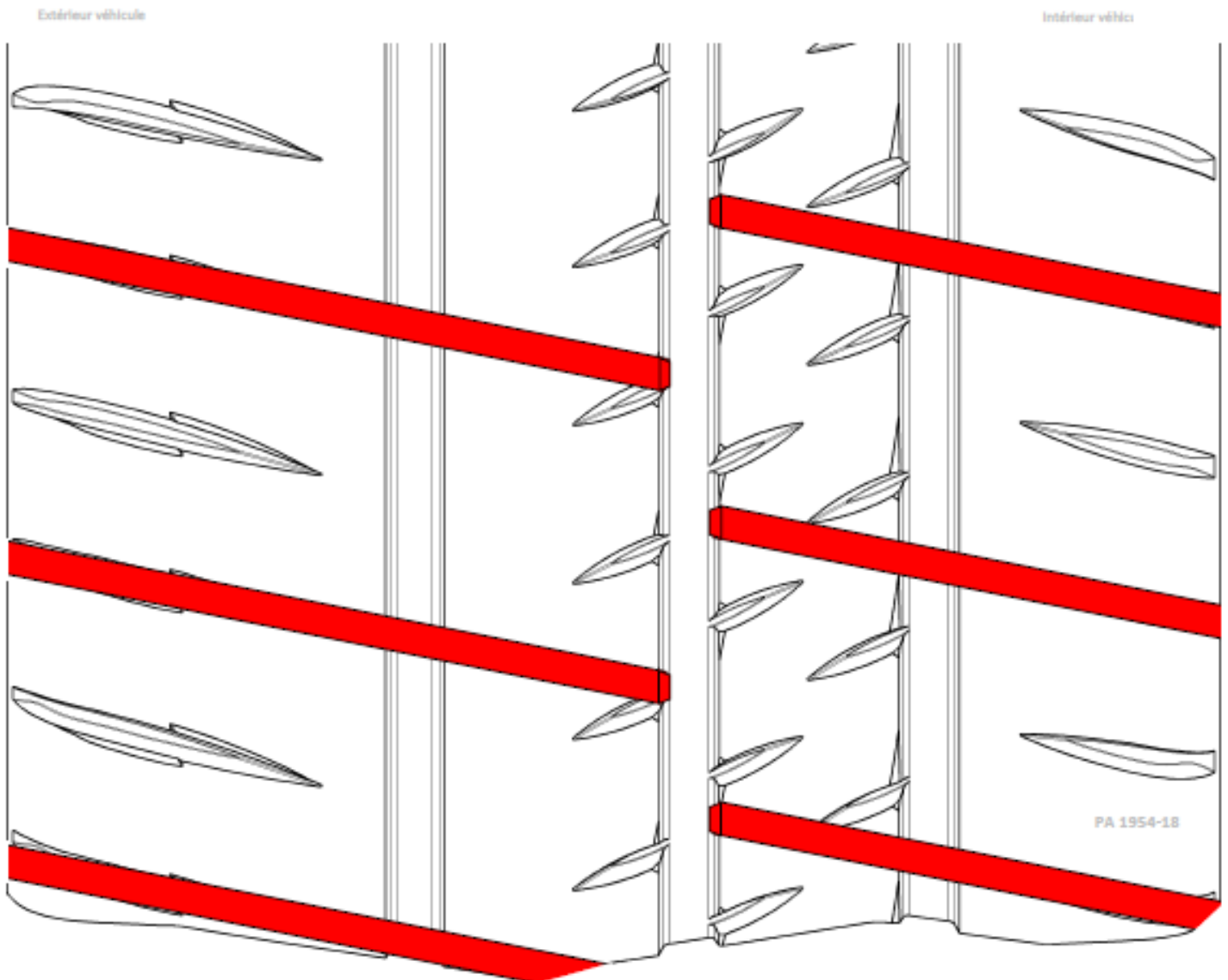
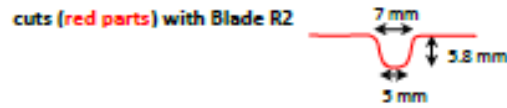



Category : Asphalt Rally

Clermont-Ferrand the 20/05/2020

Dimensions : 20/65-18, 20/63/17, 19/63-17, 19/60-16, 20/58-15, 19/58-15, 16/57-14

Cutting plan of Pilot Sport R tread pattern

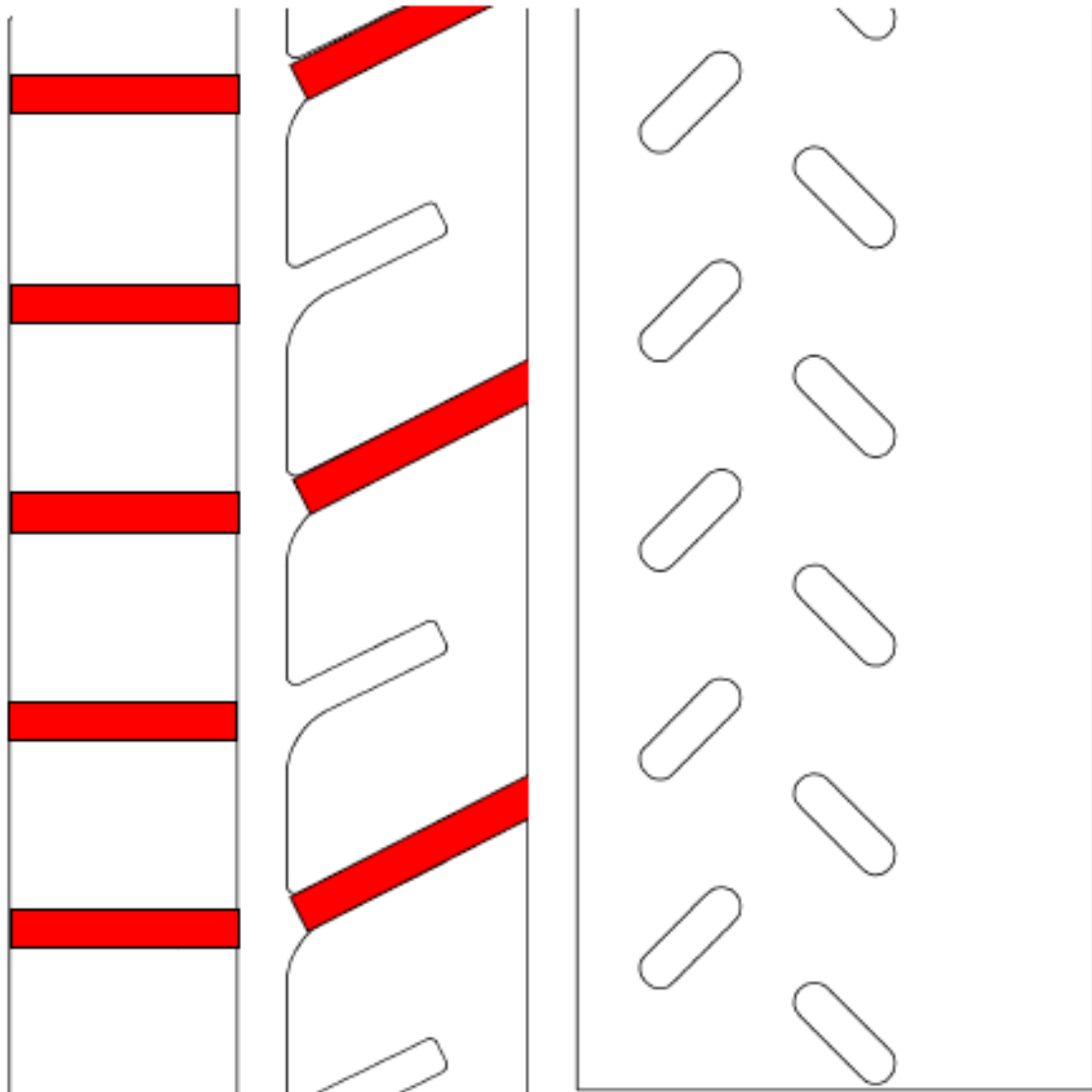
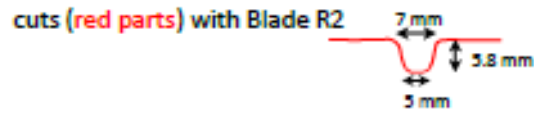

MICHELIN 19/60-16 & 19/63-17 TL PILOT SPORT PRO RALLY hand cut pattern

Clermont-Ferrand the 02/19/2023

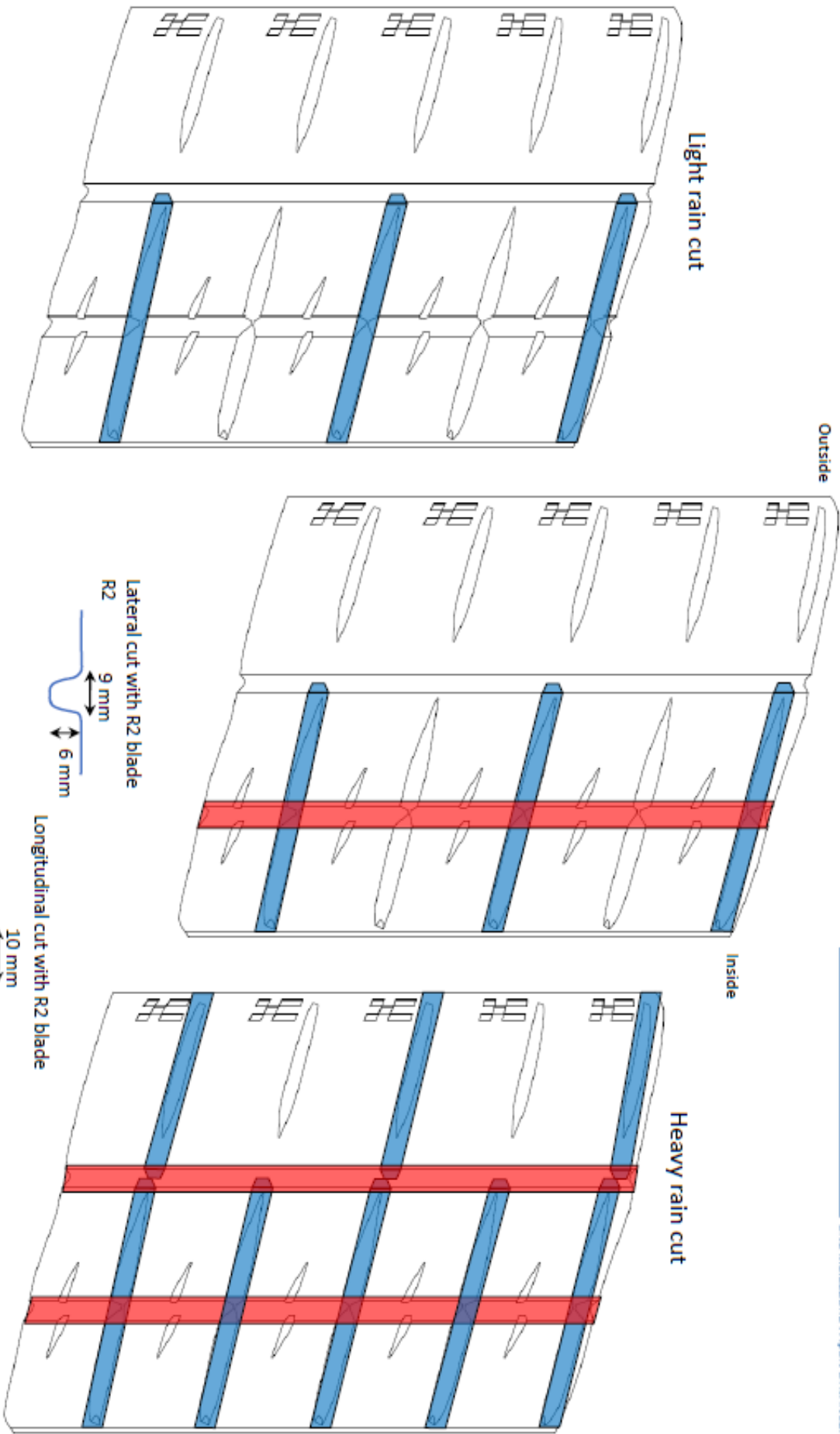

MICHELIN 20/65-18 TL PILOT SPORT A hand cut pattern

Clermont-Ferrand the 02/19/2023

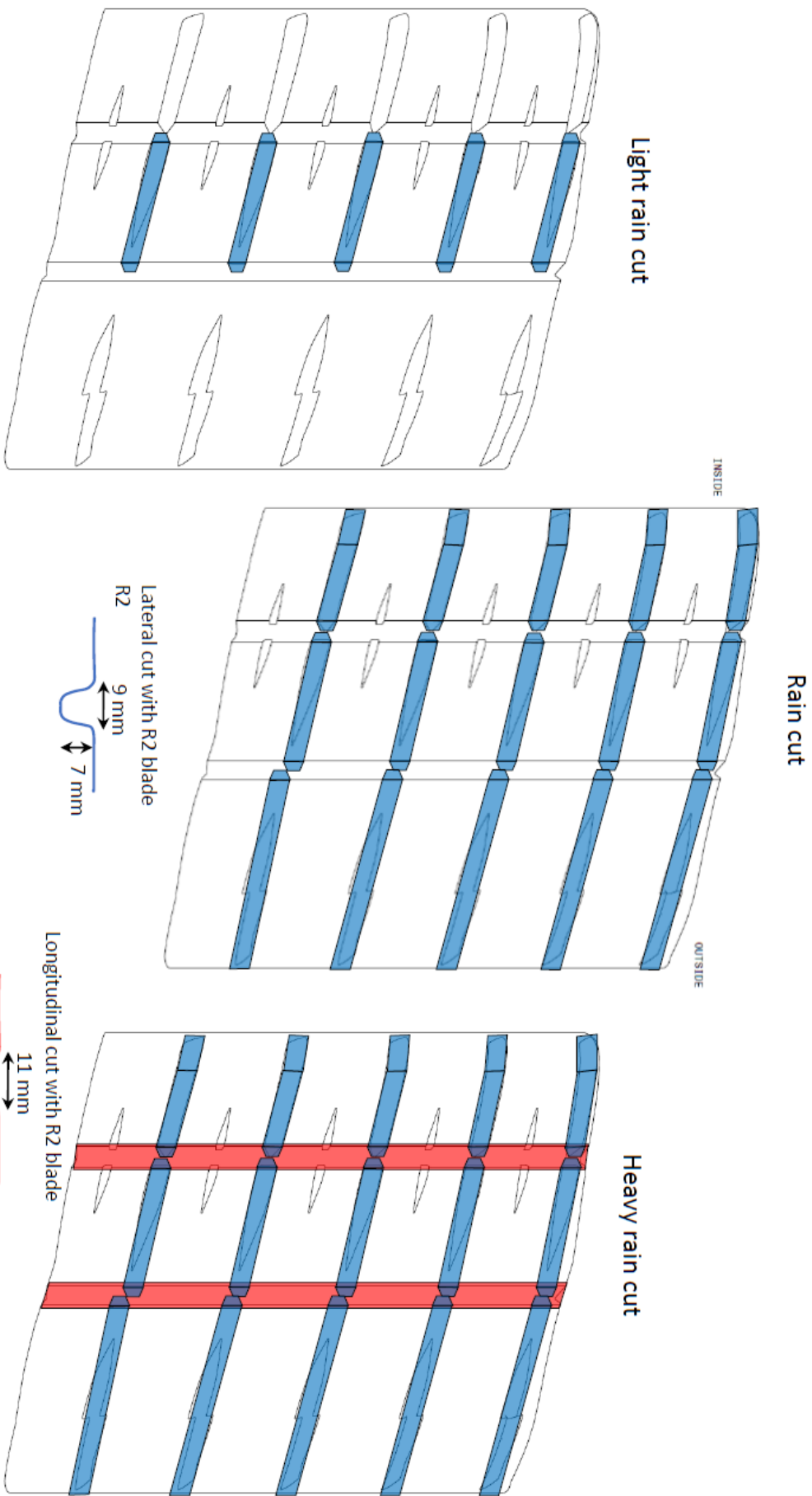

NEW 2024

Domaine : Rallye Asphalte
Dimension : 20 / 65 - 18 TL Pilot Sport A MW1
Plan de cut



Clermont-Ferrand le 27/03/2024

Côté Extérieur véhicule

Côté Intérieur véhicule

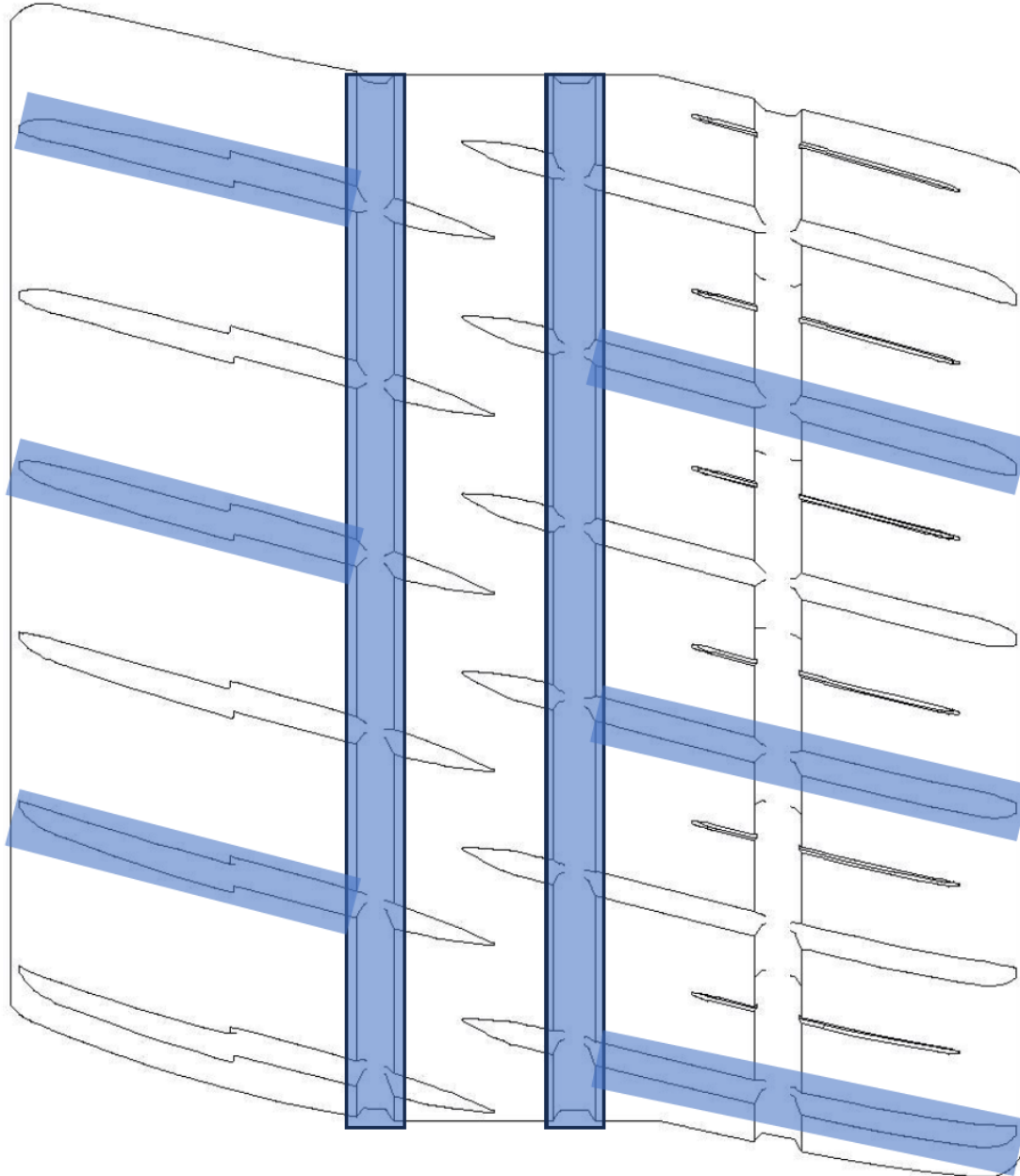

NEW 2024

Domaine : Rallye Asphalte
Dimension : 19/60-16 TL Pilot Sport A MW1
Plan de cut



Clermont-Ferrand le 01/10/2024

Côté Extérieur véhicule

Côté Intérieur véhicule

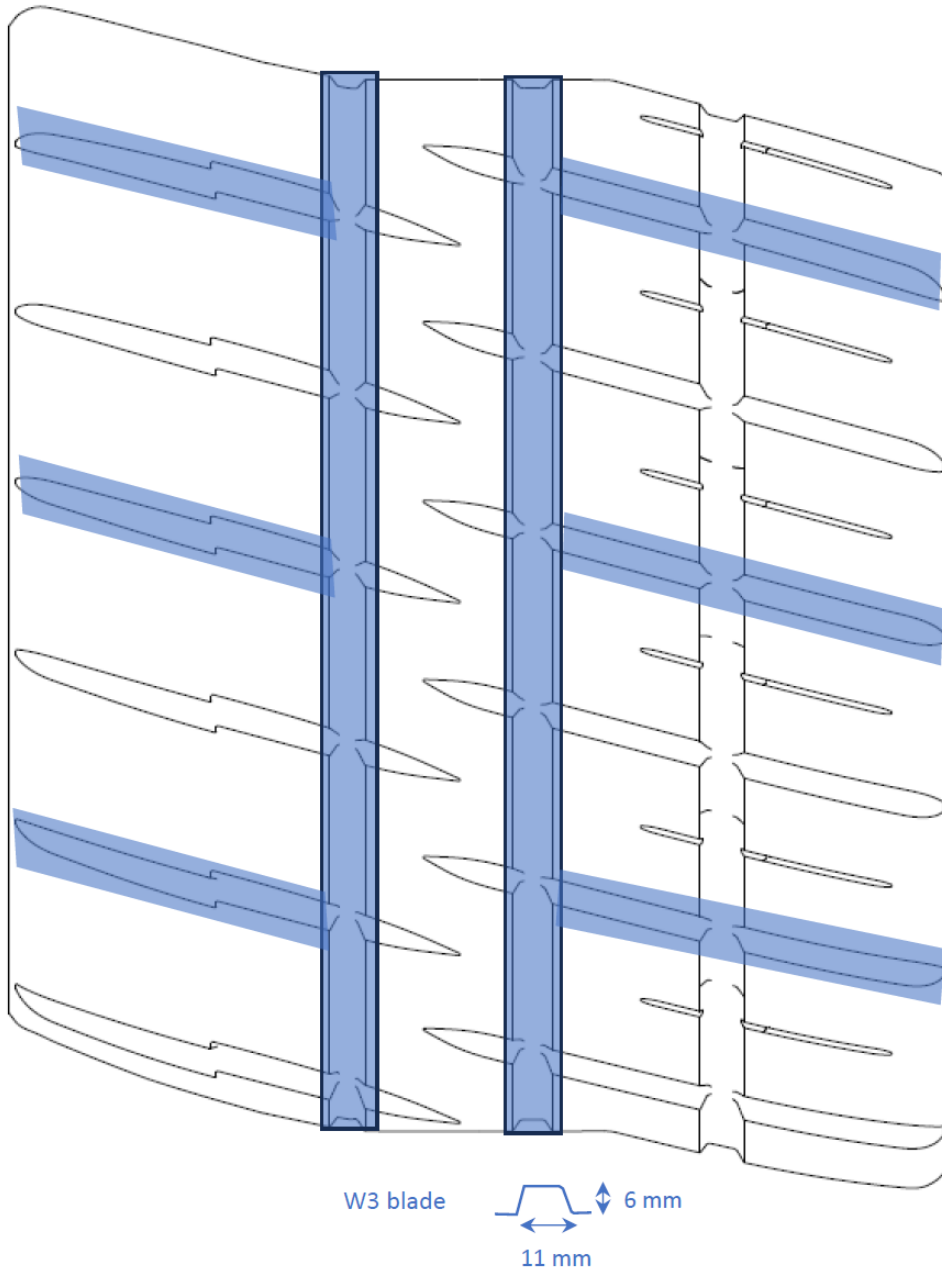

NEW 2024

Domaine : Rallye Asphalte
Dimension : 19/63-17 TL Pilot Sport A MW1
Plan de cut



Clermont-Ferrand le 01/10/2024

Côté Extérieur véhicule

Côté Intérieur véhicule

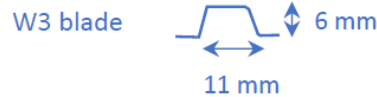
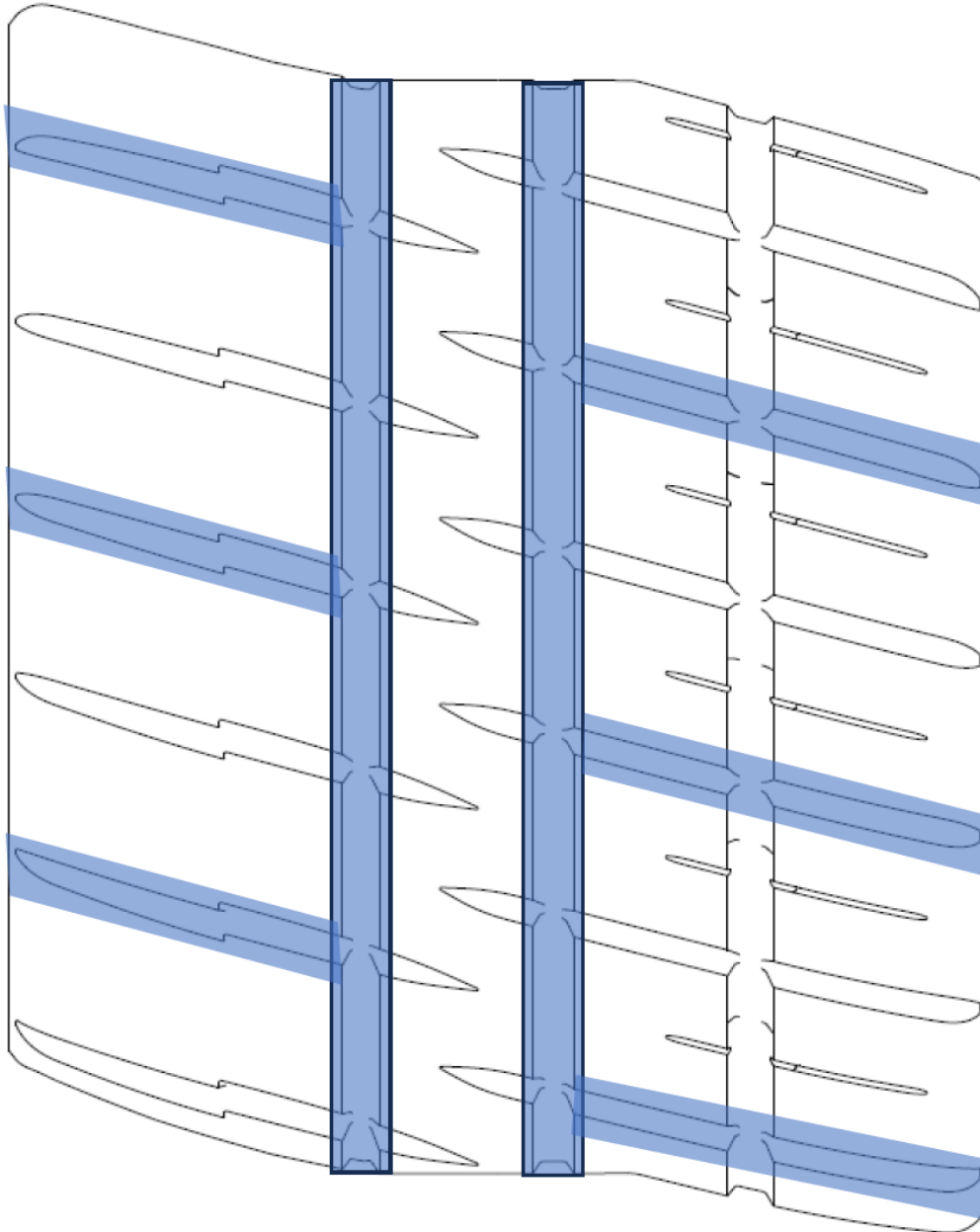



235/40R18 PZERO RA
205/45R17 PZERO RA
195/50R16 PZERO RA

Cut 1 for Damp conditions



W = 6 mm
D = 6 mm
Blade R2

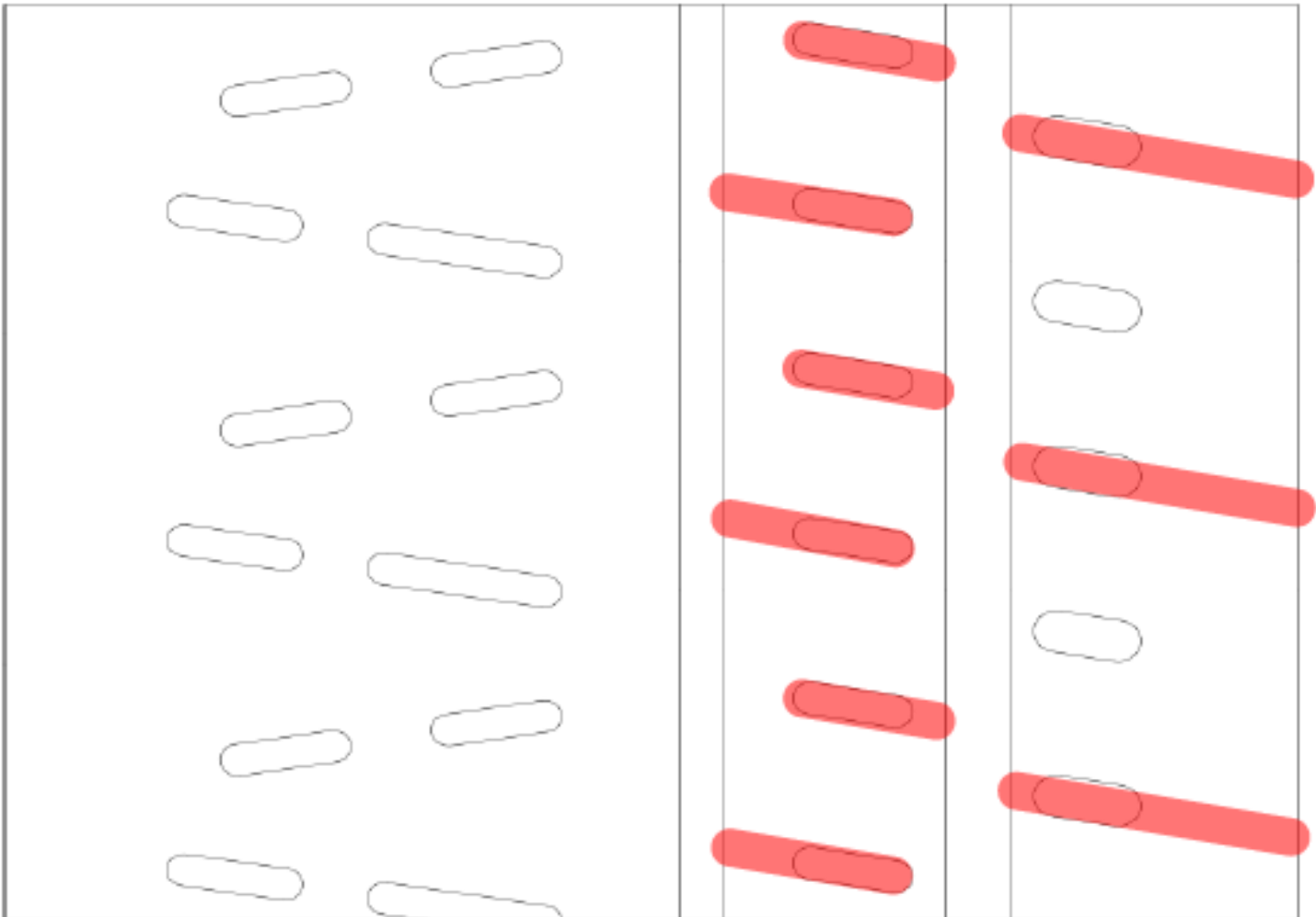



235/40R18 PZERO RA
205/45R17 PZERO RA
195/50R16 PZERO RA

Cut 3 for Wet conditions



W = 6 mm
D = 6 mm
Blade R2

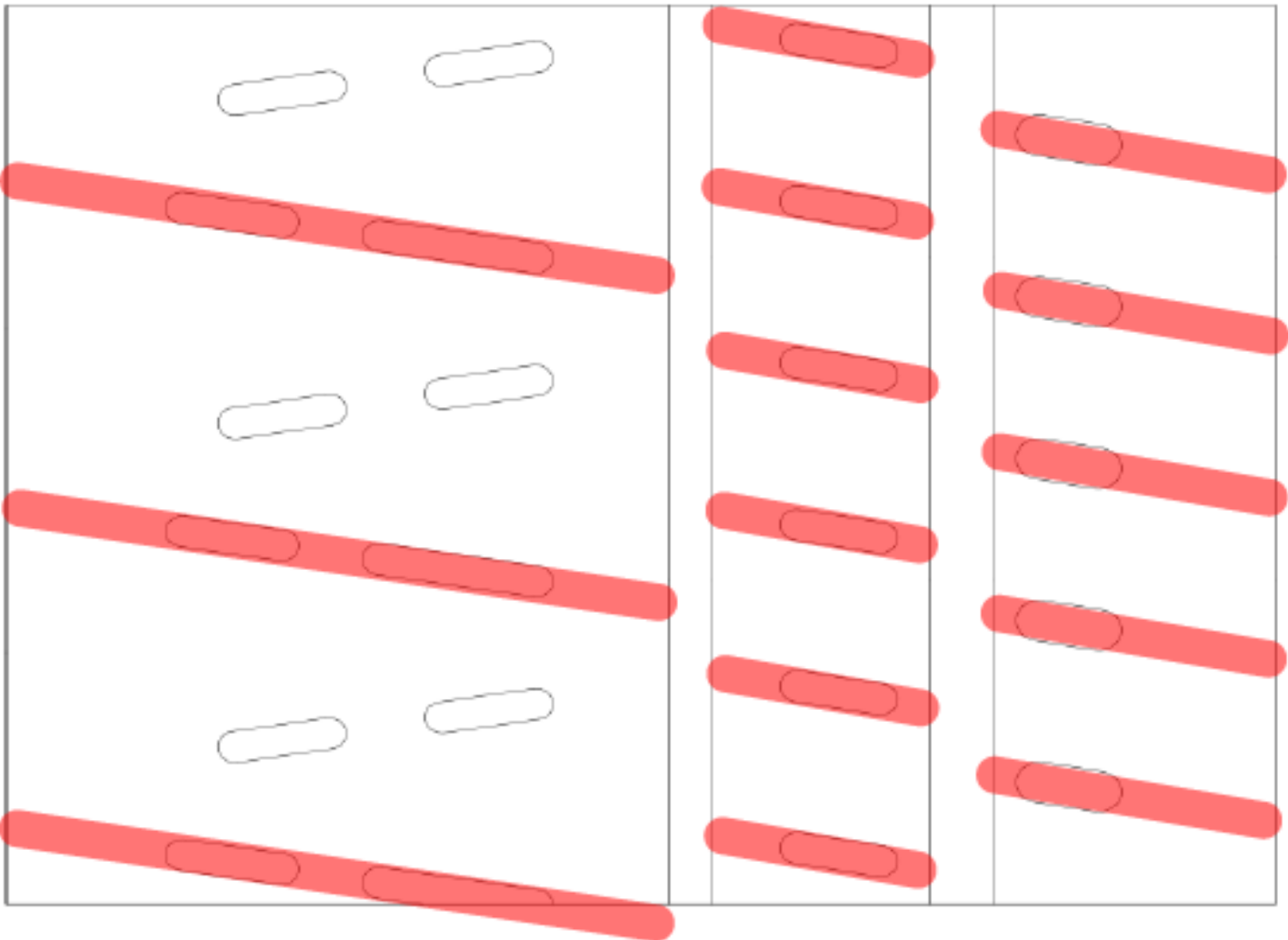



235/40R18 CINTURATO RW
205/45R17 CINTURATO RW
195/50R16 CINTURATO RW

Cut 4 for Wet conditions with standing water on the stage



W = 8 mm
D = 7 mm
Blade W4



W = 6 mm
D = 7 mm
Blade R3

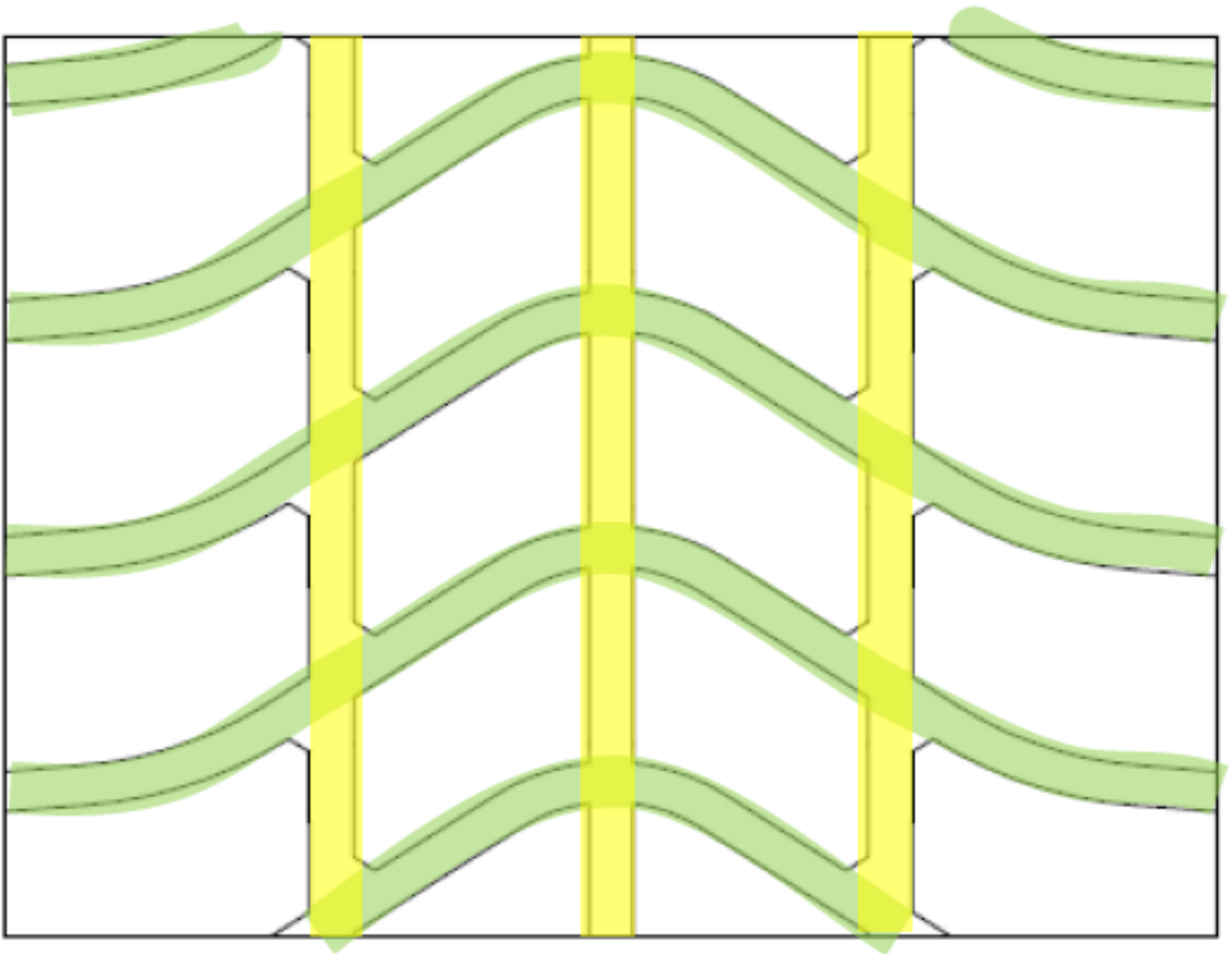



Tarmac Rally tire hand cut pattern for wet

(Cut red marked area)

**195/50R13 (200/530R13), 225/45R13 (220/530R13),
195/50R15, 225/45R15**

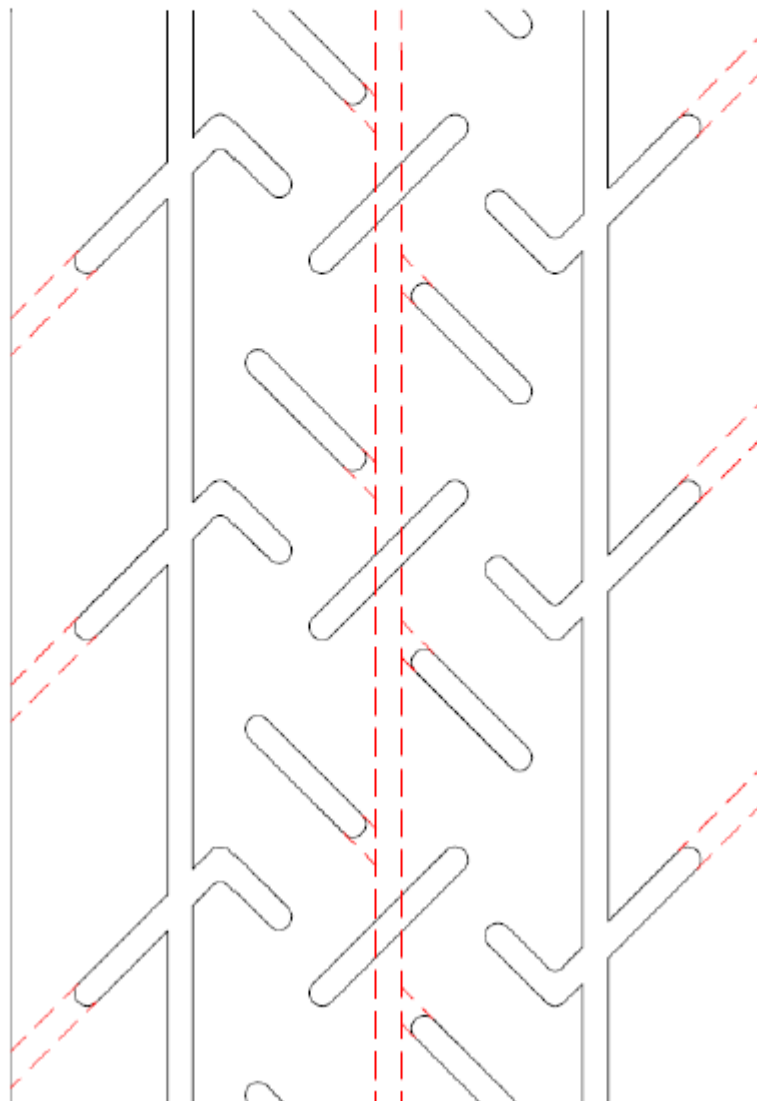



Tarmac Rally tire hand cut pattern for wet
(Cut red marked area)
195/50R16, 195/50R17, 225/40R18

Light Rain

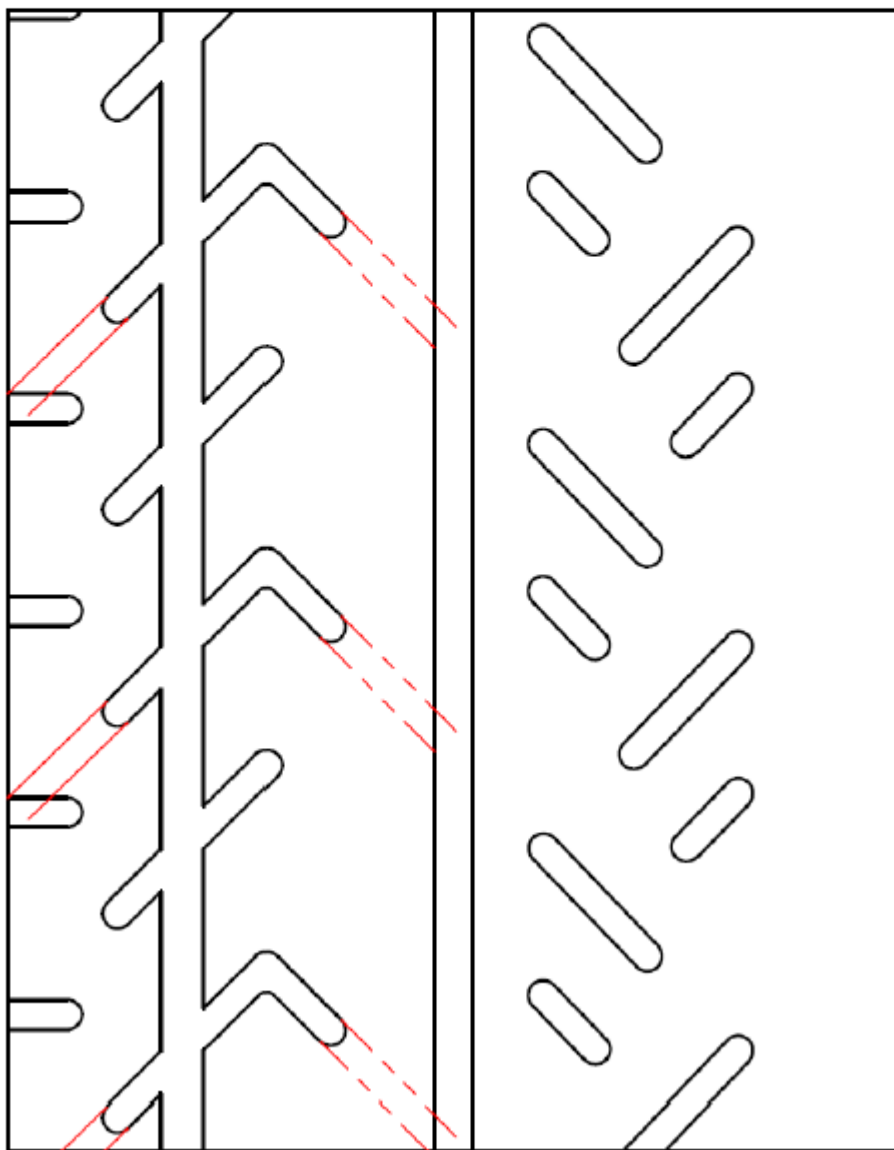



Tarmac Rally tire hand cut pattern for wet
(Cut red marked area)
195/50R16, 195/50R17, 225/40R18

Medium Rain

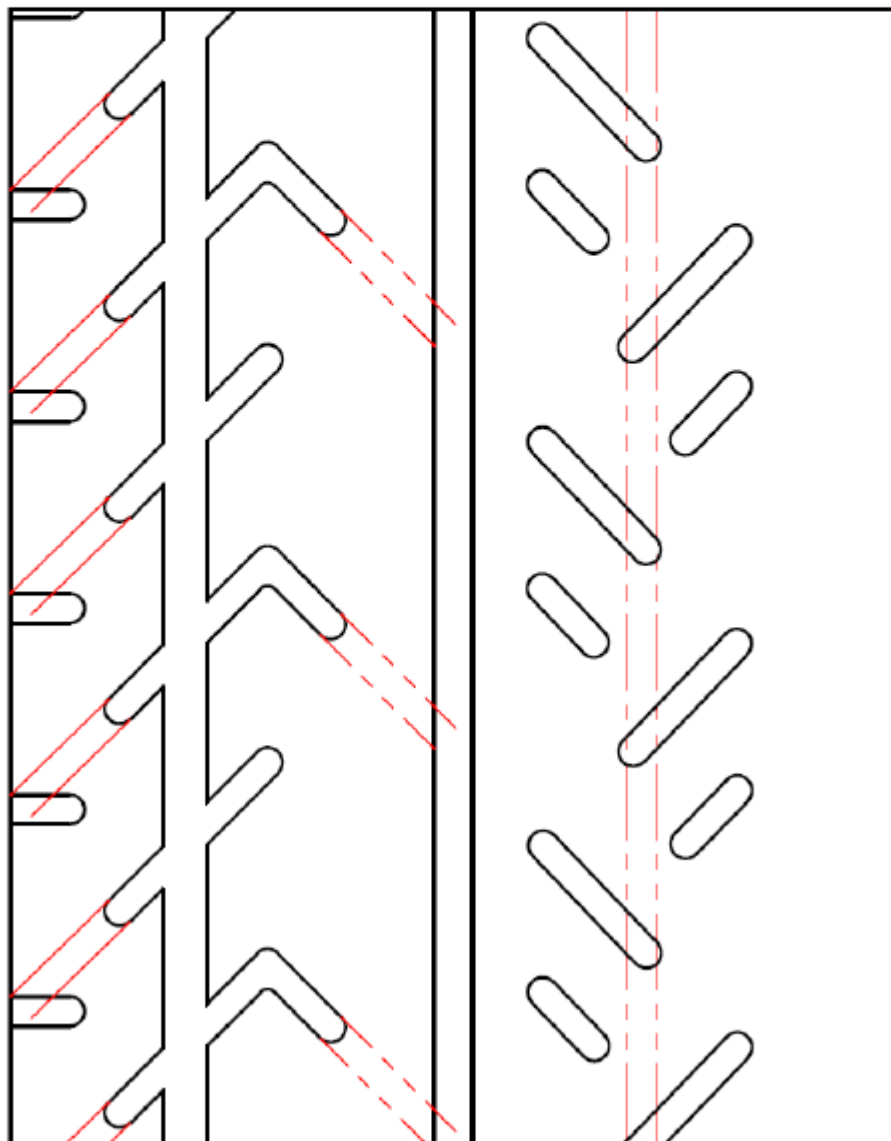



Tarmac Rally tire hand cut pattern for wet
(Cut red marked area)
195/50R16, 195/50R17, 225/40R18

Heavy Rain

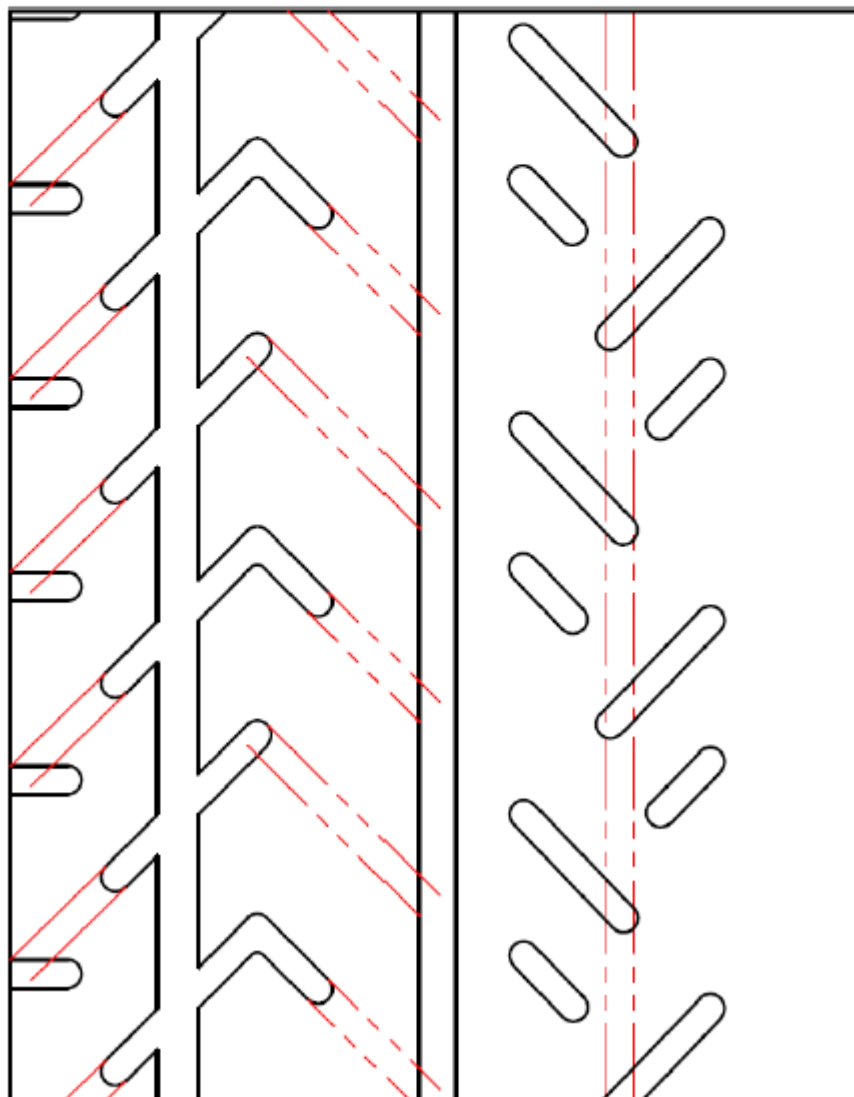

EXTREME VRC 27/66-18

Hand-cut pattern: damp

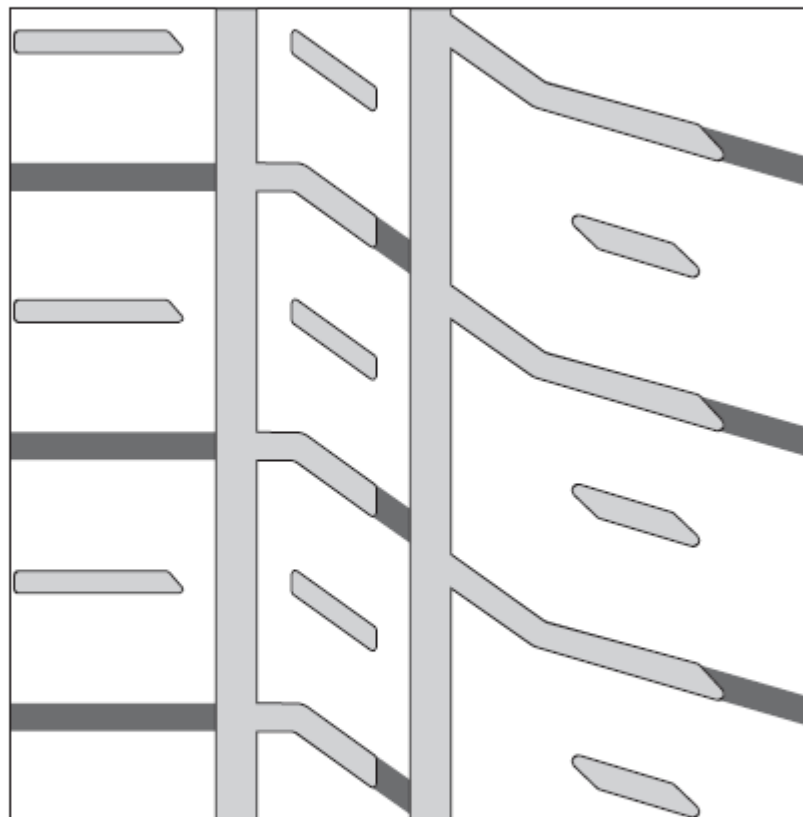



 groove: 9mm width; 6,5mm depth

Scale: 1:2

EXTREME VRC 27/66-18

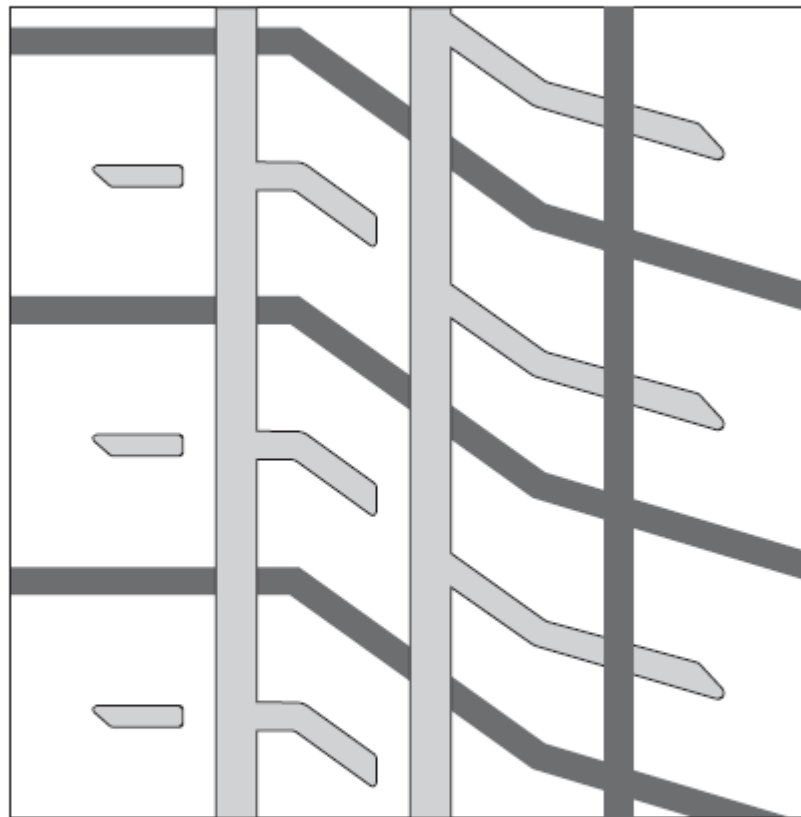
Hand-cut pattern: extra wet



 groove: 9mm width; 6,5mm depth

Scale: 1:2



RAIN CUT

HEAVY RAIN CUT

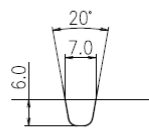
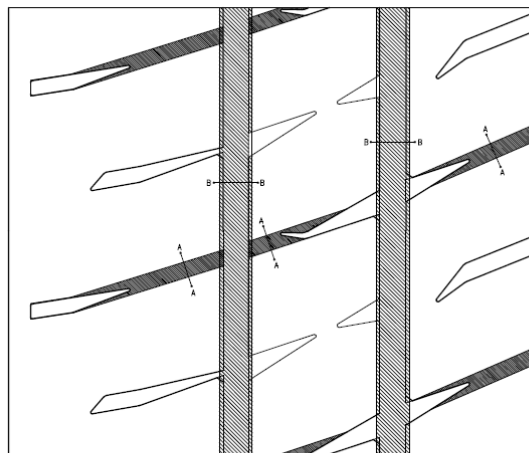
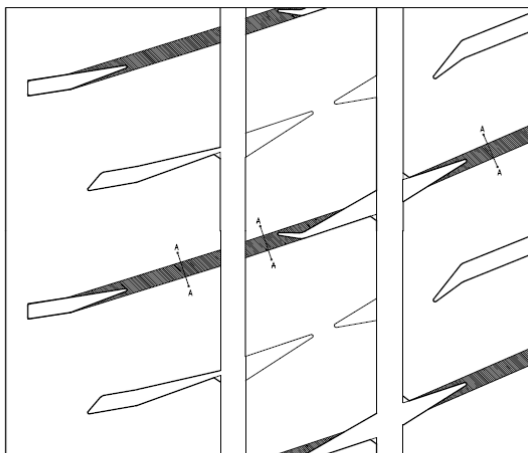

A-A

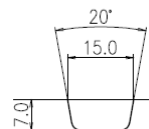

B-B

CUT WET PATTERN	 SUMITOMO RUBBER INDUSTRIES,LTD. MOTOR SPORTS DEPARTMENT	Size · Pattern
		210/650R18
		190/625R17
		DIREZZA 301R

HANKOOK Ventus Z215 Recut guide

Sizes: 210/650R18, 190/630R17, 190/600R16

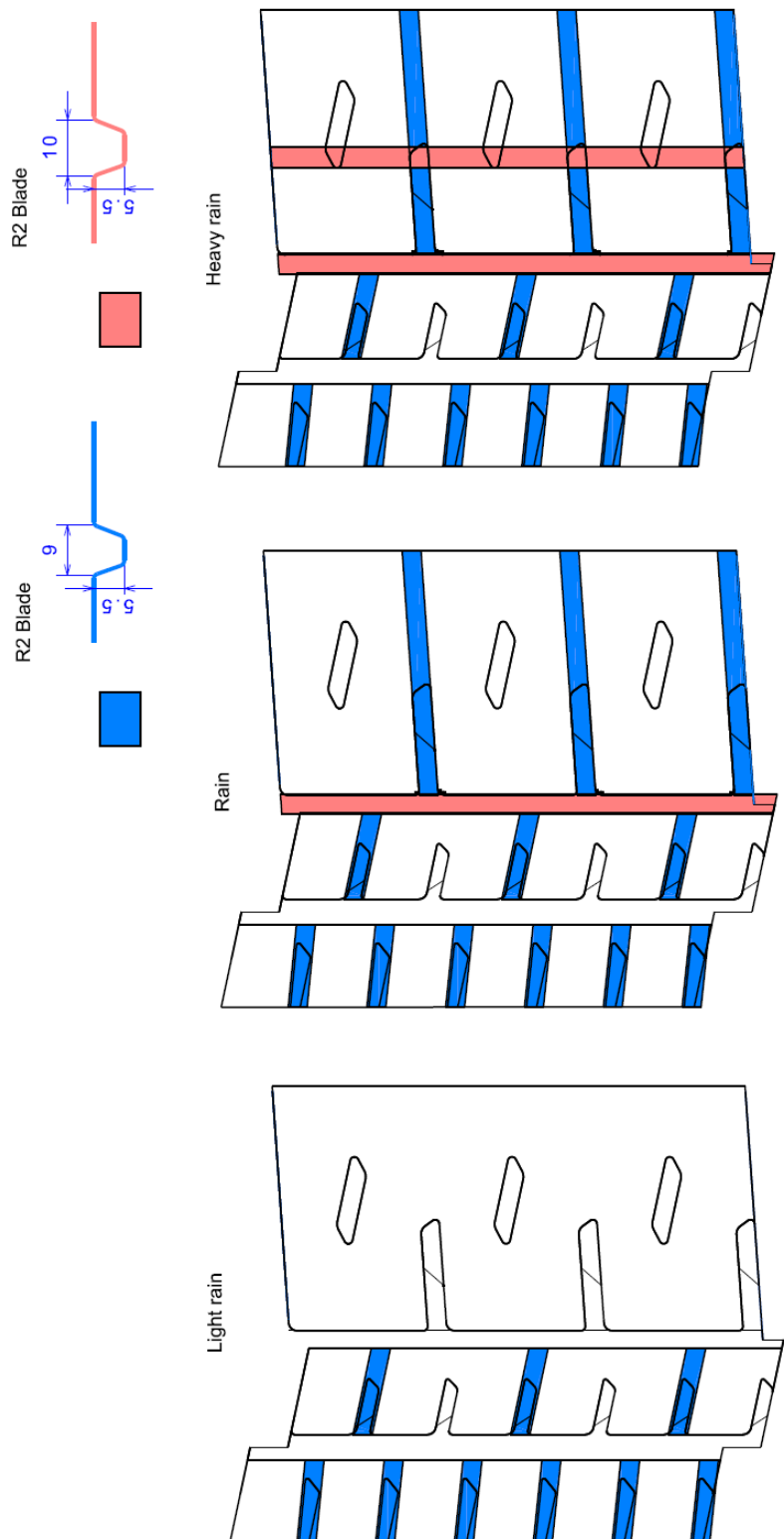

HANKOOK Ventus Z205 Recut guide

Sizes: 210/650R18, 210/625R17, 180/625R17, 180/600R16, 200/580R15, 190/580R15, 170/560R14

